

YTO YT- A, B, J, M Series Engines

**OPERATION & MAINTENANCE**

**MANUAL**

## Foreword

YTO (Luoyang) Power Machinery CO. Ltd is a joint venture subsidiary with China YTO Group Corp. based on technology transfer from Ricardo Consulting Engineers, the YTO YT- A, B, J, M series diesel engines are new, high power engines jointly developed China YTO Group Corp.. It meets the requirements of GB/T 1147.1 General Technical Requirements of Small and Medium Power Internal Combustion Engine.

Based on in-line ,water-cooled, four-stroke ,direct-injection construction, the engine of 2,3,4 cylinders have natural-aspirated , turbo-charged and turbo-charged with intercooler versions with bore diameter of 100,102,105,108 and 110mm stroke of 108,120,125 and 130mm.The power ranges from 18 to 100kW at the range from 1500 r/min to 2600r/mim.

Continuing improvement and advancement of product might have caused changes to the engine specification, structure, adapted accessories, etc. in this manual, those will be republished this operation and maintenance manual in next edition. Pay attention to some contents in this manual will be a little different from the engine that you owned.

This manual will not be a quality warranty certificate to the engine, so all the date, illustrated figures and explanations will not be based to the customer claim. All rights are reserved. No part of this manual covered by the copyright hereon may be reproduced or copied without written permission of YTO (Luoyang) Power Machinery CO. Ltd.

This manual compiling is organized by YTO (Luoyang) Power Machinery CO. Ltd. The manual involves many contents, and which have some shortcomings, so it is hoped that the readers will kindly point out our errors, these errors will be corrected in new edition manual. At same time, we hope all our users cooperates with us sincerity to give our opinions about the product quality, performance, structure after-sales service and etc. in order to improve the product and perfect level and make greater contributions to society together.

## Dear user:

Acknowledgement for you to trust our brand YTO YT- A, B, J, M series diesel engines, welcome to use the engine made by YTO (LUOYANG) POWER MACHINERY CO.,LTD.

The operation and maintenance manual contains product structures, performances, safety, operation, adjustment, maintenance information. For the best use of the engine and your safety, we remind you reading this manual in detail before use the engine.

In order to better understand the main contents in this manual, we set some indicative symbol, which will remind you to notice the information during operating engine.

YTO YT- A, B, J, M series diesel engines are all introduced in this manual. This manual will not use specific engine model, simple call engines, and give explanation for different structures.



**Tips logo:**Involved, including security, operations and other elements of the important information.



**Warning symbol:** warning information which involves personal injury property loss due to violation operation.



**Fireproof symbol:**warning information which involves property loss due to fire caused by incorrect operation.



**Maintenance symbol:**warning information which involves correct operation and maintenance.

For any question or requirements to the product quality or service please contact our hot line 086-0379-64245033. Thank you.

## Contents

|  |      |
|--|------|
| <b>Chapter 1 Brief Introduction</b> .....                              | (1)  |
| 1 Products Introduction .....  | (1)  |
| 2 Recognizing the Engine .....   | (2)  |
| 3 Important Safety Information .....                                   | (4)  |
| 4 Name Plate and Identification Number .....                           | (6)  |
| <b>Chapter 2 Engine Usage</b> .....                                    | (7)  |
| 1 Fuel/Lubrication/Coolant .....                                       | (7)  |
| 2 Before First Operation .....   | (9)  |
| 3 Starting the Engine .....  | (10) |
| 4 Operating the Engine .....   | (11) |
| 5 Stopping the Engine .....  | (12) |
| 6 Running in .....   | (12) |
| <b>Chapter 3 Maintenance</b> .....                                     | (14) |
| 1 Technical Maintenance .....  | (14) |
| 2 Daily Maintenance .....  | (14) |
| 3 Class I Maintenance .....  | (16) |
| 4 Class II Maintenance .....   | (18) |
| 5 Class III Maintenance .....  | (20) |
| 6 Turbocharger .....   | (22) |
| 7 Maintenance in Winter Season .....                                   | (23) |
| 8 Engine Storage .....   | (24) |
| <b>Chapter 4 EUP Fuel Injection System Operation Instruction</b> ..... | (25) |
| 1 System Constitution .....  | (25) |
| 2 Each Part Function and Sensor Installation Position .....            | (26) |
| 3 System Operation .....   | (28) |
| 4 Maintenance .....  | (29) |
| 5 Fault Diagnosis .....  | (30) |
| <b>Chapter 5 Main Component Installation &amp; Adjustment</b> .....    | (32) |
| 1 Cylinder and Crank and Connecting Rod Mechanism .....                | (32) |
| 2 Cylinder Head and Valve Mechanism .....                              | (35) |
| 3 Turbocharger and Intercooler System .....                            | (39) |
| 4 Lubrication System .....   | (41) |

|  |  |             |
|--|--|-------------|
| 5  | Fuel Supply and Injection System .....                             | (43)        |
| 6  | Cooling System .....   | (46)        |
| 7  | Electric System .....  | (48)        |
| 8  | Sensor Interface .....   | (51)        |
| <b>Chapter 6 Troubleshooting .....</b>               |  | <b>(52)</b> |
| 1  | Engine Hard to Start .....   | (52)        |
| 2  | Running Rough .....  | (53)        |
| 3  | Lack of Engine Power .....   | (53)        |
| 4  | Abnormal Noise .....   | (54)        |
| 5  | Black Smoke .....  | (54)        |
| 6  | White Smoke .....  | (55)        |
| 7  | Blue Smoke .....   | (55)        |
| 8  | Lack of Oil Pressure .....   | (55)        |
| 9  | Coolant Is too Hot .....   | (55)        |
| 10   | Engine Stalls Abruptly .....                                       | (56)        |
| 11   | Runaway .....  | (56)        |
| 12   | Lack of Power, Higher Fuel Consumption due to Excessive Wear ..... | (57)        |
| 13   | Low Air Pressure and Oil Leaks of Air Compressor .....             | (57)        |
| 14   | Alternator Faults .....  | (58)        |
| <b>Chapter 7 Main Data of Maintenance .....</b>      |  | <b>(59)</b> |
| <b>Chapter 8 Main Technical Specifications .....</b> |  | <b>(60)</b> |
| 1  | Instruction to Specifications Table .....                          | (60)        |
| 2  | Other Instruction .....  | (60)        |
| 3  | Specifications Table .....   | (61)        |

# Chapter 1 Brief Introduction

## 1 Products Introduction

YTO (Luoyang) Power Machinery CO. Ltd is a joint venture subsidiary of China YTO Group Corp. Based on technology transfer from Ricardo Consulting Engineers, the YTO YT- A, B, J, M series diesel engines manufactured by YTO (Luoyang) Engine Machinery CO., Ltd are new, high speed, middle power, energy-saving engines developed by China YTO Group Corp.

Based on in-line ,water-cooled, four-stroke ,direct-injection construction, the engines of 2,3,4 cylinders have natural-aspirated , turbo-charged and turbo-charged with intercooler versions with bore diameter of 100,105,108, and 110mm and stroke of 108,120,125 and 130mm. The power ranges from 18 to 100kW at the range from 1500 r/min to 2600r/min.

Based on good low temperature starting performance, the engine could easily be started without any assistance when the temperature is not below  $-10^{\circ}\text{C}$ ; and it could be started easily at  $-40^{\circ}\text{C}$  by using preheating measures. The engine can continuously run at the following conditions: vertical inclination  $20^{\circ}$  ,horizontal inclination  $15^{\circ}$  ,  $-40^{\circ}\text{C}$  to  $+50^{\circ}\text{C}$  ambient temperature. The engine can install some PTO (power take-off) devices, and can output full or part of the power from front end of the crankshaft so as to meet different requirements.

The altitude type turbo-charged engines have passed construction machine quality certification test for the plateau of 4500 meters above sea level, which have a better regional adaptation. Four valves, turbocharged and turbocharged-middle-cooled, air intake passage optimum simulation, double-shaft balance for four-cylinder diesel engine, electronically controlled fuel injection, and other core patent technologies have been successfully applied, which make the series diesel engines have lower noise, lower vibration , lower oil consumption , lower emission , and so on. Through EGR internal recycle control and water-cooling EGR control technology, all products have been granted China environmental protection certification, Europe e-mark type approval, USA EPA3 certificate.

YTO YT- A, B, J, M series diesel engines have been widely used as power sources for vehicles, tractors, construction machinery, generator sets ,small generating stations and marines.

Golden service is our service brand. About 400 customer service nets , 300 prepare spare parts supply system, and product querying system have been set up all over China, which can provide satisfactory whole course service for our customers.

## 2 Recognizing the Engine

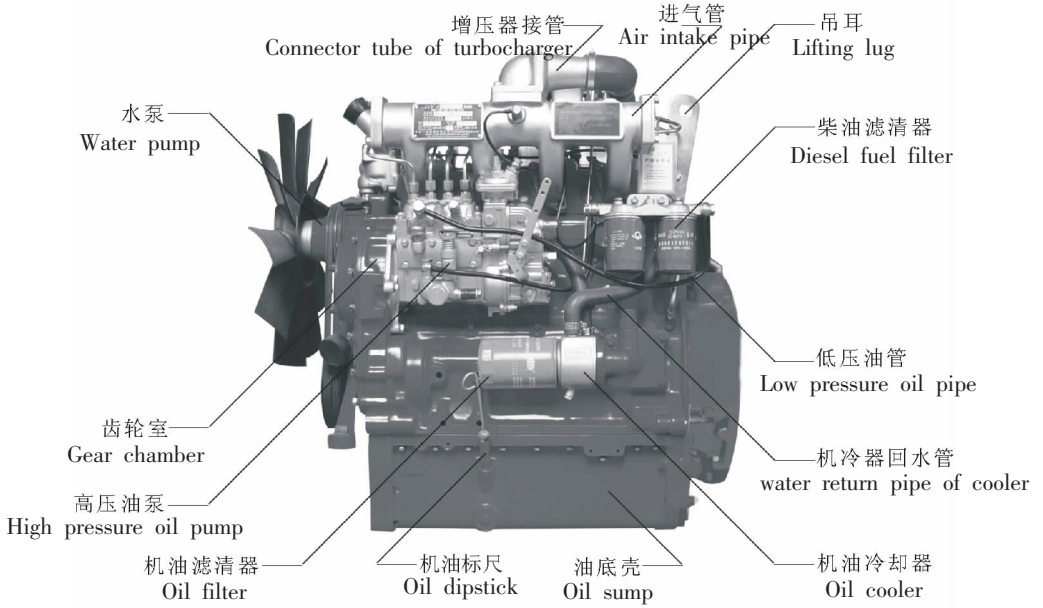

Fig1-1 Left-side view

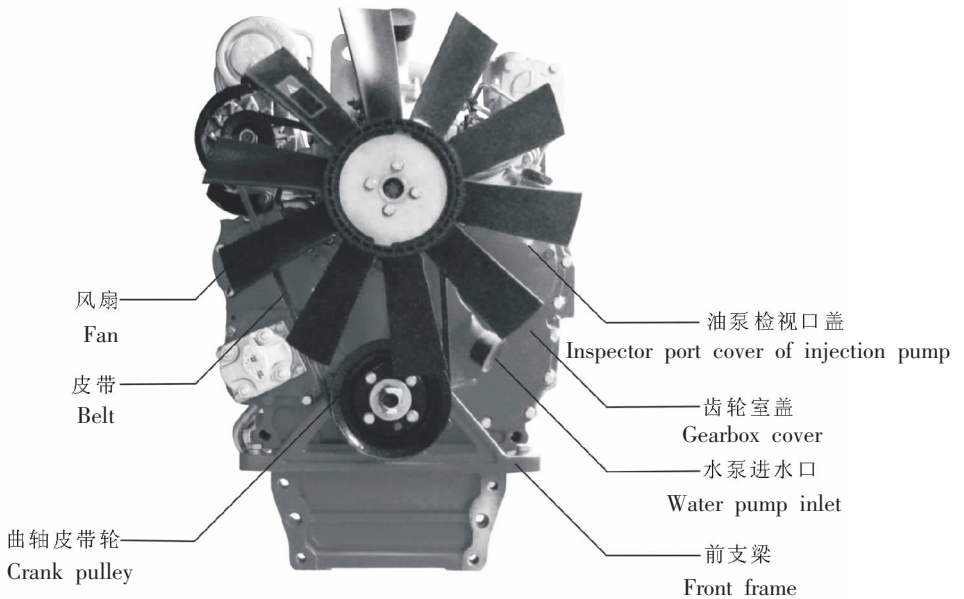

Fig1-2 Front view

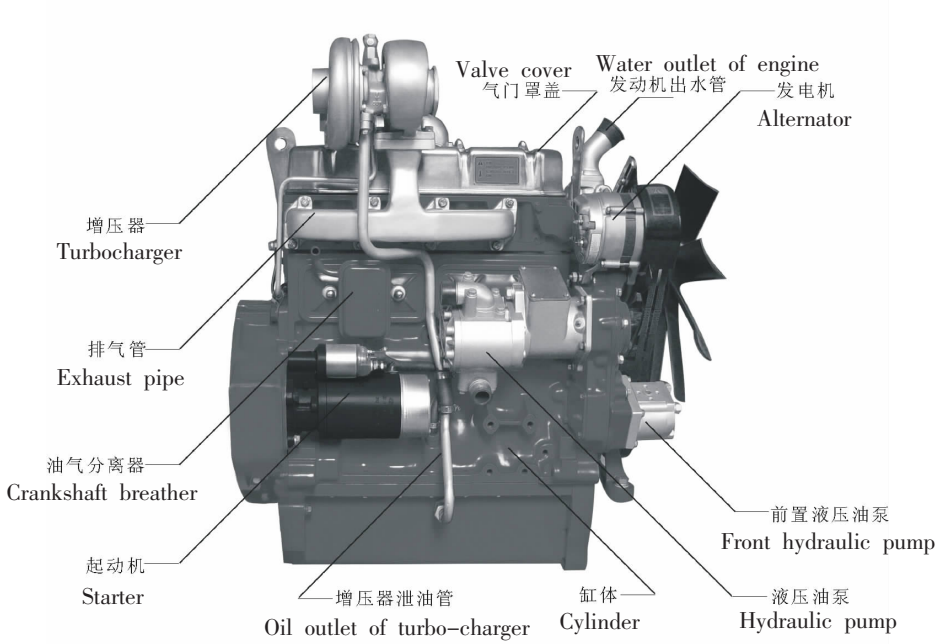

Fig1-3 Right view

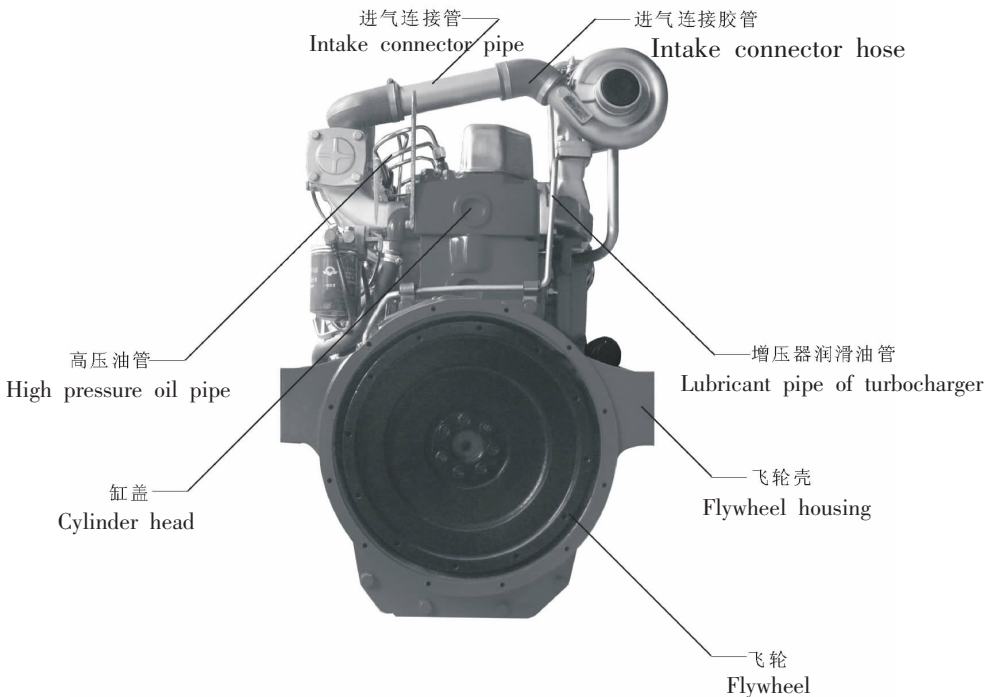

Fig1-4 Rear view



### 3 Important Safety Information

#### 3.1 Before Starting the Engine



The product that you selected conforms to Chinese safety standard. It will be well worth to read this manual from cover to cover prior to putting the engine into operation. It covers important information about engine installation, use and safety instruction. If you do not obey above instructions, when engine have some faults, the manufacturer will not take any responsibility. Follow the instruction of this manual to run in the engine, use the engine and maintain the engine.

#### 3.2 General Safety Rules



Never try to approach the turning parts when the engine is running (see Fig1-5). The protective devices should be installed when turning parts, such as fan, belt and fly wheel are exposed outside during operating engine. Do not try to disassemble, adjust & maintain the engine when engine is running. All the works should be done after stopping the engine.



Fig.1-5 Located on Alternator Hood



Fig.1-6 Located below Exhaust Pipe

3.2.2 When engine is working, the temperature at the turbocharger, exhaust pipe, muffler and radiator is very high, the protective devices should be installed. Pay attention to keep your body away from the engine to avoid hot injure (see Fig1-6).



3.2.3 Do not add the coolant to the engine at hot engine temperature. To avoid hot injure, please wait the coolant temperature lower down after engine is stopped.

3.2.4 Do not operate the engine in room or closed place. Pay attention to have good Ventilation in order to avoid personal injury.



3.2.5 Keep engine away from flame when adding fuel and lubrication to the engine. Meanwhile, Exhaust gas has also very high temperature, please install spark extinguish devices to exhaust pipe or the muffler if the engine is located nearby the flame-able materials.

### 3.3 Use Information



3.3.1 Lubricant Selection: Naturally aspirated diesel engine should use no lower than CD grade engine oil. Turbocharged Diesel Engine should use CF grade or above CF grade engine oil. Do not mix the new oil with the used oil or other grade oil.



3.3.2 Do not operate the engine without air filter. Often check the air inlet pipeline (Including connecting pipe lines between the turbocharger and the inter-cooler) in order to ensure the sealing performance.

3.3.3 Do not try to dismount the turbocharger. For turbochargers with waste gate valve, do not try to dismount or remove the valve controller and its support.

3.3.4 Electric circuit connection should be correct and firmly. Do not dismount connection lines to avoid accidents when alternator is running.

3.3.5 When engine works without oil pressure or low oil pressure, high coolant temperature, abnormal noise in the engine, stop the engine immediately, find out the causes and correct them.



3.3.6 When the engine runs away, cut off the fuel supply pipe or block up the intake pipe immediately.

### 3.4 After Operation



3.4.1 Stopping the engine suddenly is prohibited when coolant is in high temperature. Before stopping the engine, reduce the load and speed, let the engine run stably for 2-3 minutes, and then do not stop the engine until the coolant temperature is below 70°C.



3.4.2 If the engine need to store for a long period at the temperature below 0°C, if the engine does not use antifreeze, drain out the water in the cooling system or add antifreeze as coolant to prevent the engine damaged due to freezing.

### 3.5 Fault Appearance



3.5.1 Without allowance of special service centers of the manufacturer, never overhaul and maintain the engine by customers within the warranty period when the fault happens to the engine.

3.5.2 Do not try to remove and adjust the lead seals on the injection pump.



3.5.3 Please contact our hot line 086-379-64245033.

3.5.4 Please provide the accurate contents on the nameplate for the special service stations when your product needs service.

#### 4 Name Plate and Identification Number

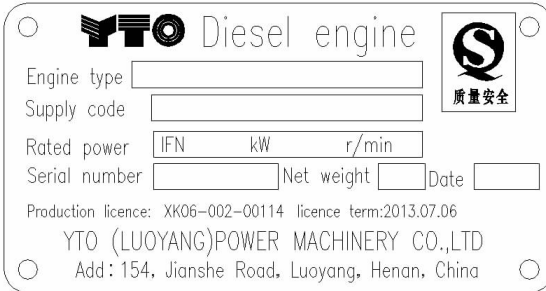

Fig1-7 Name Plate

Number

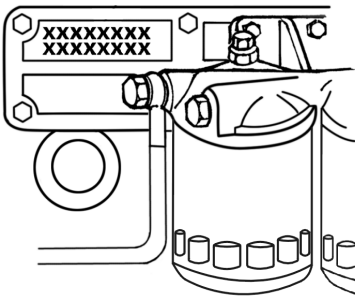

Fig1-8 Engine Serial Number

Nameplate is located on the outside of intake pipes. There are the main data and information for warranty claims and ordering spare parts. The contents on the nameplate for engines are shown on Fig 1-7.

The serial number on the nameplate is the same as the number on the engine block (see Fig 1-8). Please check them carefully as it is required for customer to get after sale service. The serial numbers are located on the different places on the engine block depending on models, most of them are located at the side of fuel injection pump or on the cover board.

Notice: there is not supply symbol on the name plate of some engines.



Without allowance by the manufacturer, changing nameplate or the engine serial number is prohibited. If you do it, this means that you will forwardly give up your rights.

## Chapter 2 Engine Usage

### 1 Fuel/Lubrication/ Coolant Selection

#### 1.1 Fuel Selection

Fuel used is light diesel that must meet China Standard: GB 252 - 2000. For different ambient temperatures, relative grade diesel fuel must be used, see Table 2-1.

Table 2-1 Ambient Temperature and Fuel

| Ambient Temperature(°C) | ≥4°C | ≥-5°C | -5~-14°C |
|-------------------------|------|-------|----------|
| Fuel Grade              | 0    | -10   | -20      |

Each performance index of the engine is related to fuel grade, less than required fuel grade can influence the engine performance.

In order to prolong the service life, fill the engine with only clean diesel fuel. Fuel container must be clean and specialized. When filling the fuel into the engine, it's better to adopt sealing method. Do not fill fuel until fuel deposits for three to seven days, and take the fuel from topside of the container or barrel. Pay attention to keep the fuel clean during the transportation, filling and usage to avoid the fuel be contaminated.



When filling or operating the engine, you should stop the engine and keep the engine away from flame or other danger sources.

#### 1.2 Lubricant Selection

1.2.1 Lubricant Selection: Naturally aspirated diesel engine should use no lower than CD grade engine oil; Turbocharged diesel engine should use CF grade or above CF grade engine oil.

1.2.2 Lubricant selection in different ambient temperatures (see Tab 2-2).

Table 2-2 Ambient Temperature and Lubricant

| Ambient Temperature(°C) | >10°C | -10°C~30°C | -25°C~-10°C |
|-------------------------|-------|------------|-------------|
| Lubricant Grade         | 40    | 15W/40     | 5W/30       |

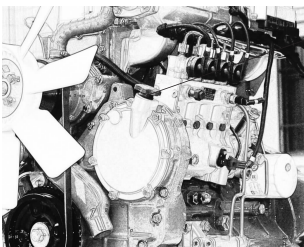

oil filler

#### Usage notice for turbocharged diesel engines

- 1 Choose relative CF grade oil according to different ambient temperatures.
- 2 Clean or replace oil filter after the engine works for more than one week. Before starting engine, add oil into the turbocharger.
- 3 After starting the engine, first of all, let the engine run at the idle speed for 3 minutes, and the engine speed should not be increased until the bearings in turbocharger have a sufficient lubrication.
- 4 Before stopping the engine, let the engine run at the idle speed for 3 minutes in order to reduce the speed of the turbocharger vastly and make the turbocharger operate reliably.

Fig2-1 Oil Filler

Engine Oil and Operation Prompting(Located on Intake Pipe)

### 1.2.3 Adding the Lubricant:

Add specified lubricant from oil filler, and wait for 5 minutes, check the oil level on the dipstick, make sure the oil level between the upper mark and lower mark (see Fig2-2).

If the engine has a additional oil cooler, for the first time to filling oil into the engine, may add a little bit more, let the engine run for 3 to 5 minutes, then stop the engine for 5 to 10 minutes, recheck the oil level and make sure the keep the oil level correctly.

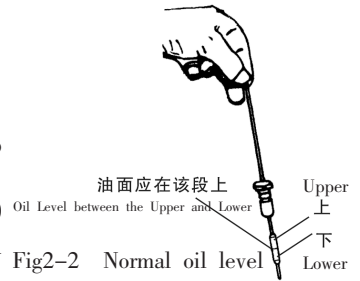

Fig2-2

Normal oil level



Oil filler

Fig2-3

1.2.4 For different configurations, the engines adopt various kinds of injection pumps, some of injection pumps adopt lubricating separated from the engine, such as ZHB pump. When adding the oil, loosen upper limit screw and add the lubricant from oil filler (see Fig2-3), do not tighten the limit screw until the oil in limit hole appears .

If there are lubricant pipes between injection pump and main oil gallery of the engine, the injection pump does not add the oil.

### 1.2.5 ZHB the use of lubricating oil injection pump

Diesel engine lubricating oil filling should be consistent with the use of lubricants.



Fig2-5 Mark in Oil Basin

### 1.2.6 Add the oil to oil-bath air cleaner

There should be enough oil in oil-bath air cleaner. Never overrun scribed line in oil basin when adding the oil (see Fig 2-5). There should be enough oil in metal screen of oil-bath air cleaner. Install metal screen after it is marinated in oil.



There should be enough and specified lubricant in the engine, injection pump and oil-bath air cleaner.

Faults which are caused by poor quality lubricant, the manufacturer will treat the customers as giving up their rights.



Never use common lubricants, do not mix different grade oil or oil from different refineries together, never mix the new oil with the used one.



Do stop the engine when filling oil, and keep the engine away from flame or other dangers.

### 1.3 Coolant Selection



1.3.1 The cooling water used in engine should be clean soft water, such as river, water, rain water, snow water, or add the engine with purchased antifreeze.

1.3.2 When the ambient temperature is below 0°C, add antifreeze additives as the coolant in order to reduce draining water or prevent the parts from damage.



Never let the engine start and run without coolant.

Never add coolant after opening radiator cap at high temperature, this would make serious personal injury.

## 2 Before First Operation



2.1 Read the operation and maintenance manual carefully before starting, performing on the engine, strictly follow the instruction in the manual for engine running-in, operation and maintenance.

2.2 Before operating the turbocharger, add a little bit oil into the inlet of turbocharger.

2.3 During the operation, never run the engine at idle speed more than 10 minutes.

2.4 If the engine need to store for a long period at the temperature below 5°C, if the engine does not use antifreeze, all the water in the cooling system should be discharged to avoid the engine damaged.



2.5 After the engine is started, do not operate the engine at high speed and load immediately, let engine at middle speed until water temperature over 60°C, and then increase the speed to maximum with full load. Do not run the engine with overload for a long time.

2.6 Continuously operating the engine is prohibited when the oil pressure is lower than 98 kPa or without oil pressure.

2.7 Do not continuously operate the engine with abnormal noise and leakage in intake system. Stop the engine, and look for any failure and correct it.

2.8 Do not use watering from outside to reduce the engine temperature when the coolant temperature is above 95°C. Let the engine run at low speed in order to gradually reduce the engine temperature.

2.9 Do not stop the engine immediately when coolant and lubricant temperature are too hot. Before stopping the engine, reduce the load and speed of engine step by step, let the engine run at low speed for 3-5 minutes. And do not stop the engine until coolant and lubricant temperature is reduced down.

2.10 Do not stomp or deposit heavy things on all exterior parts of the engine.

### 3 Starting the Engine

#### 3.1 Pre-starting Preparation

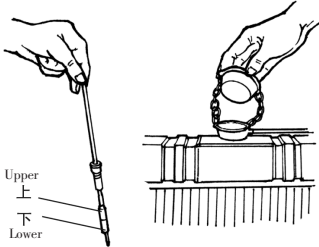

Fig2-6 Check coolant and lubricant level

3.1.1 Check coolant level and add enough cooling water (see Fig 2-6)

3.1.2 Add specified lubrication from oil inlet and wait for 5 minutes, check the oil level on the dipstick, make sure the oil level between the upper mark and lower mark.

3.1.3 make sure that the oil level of the injection pump and oil-bath air cleaner is correct.

3.1.4 Check the tightness of the connection of oil pipes, water pipes and air pipes, and make sure that there is not leakage.

3.1.5 For a new engine, a repaired engine or an engine stored for a long time, use the following procedures to bleed the fuel system before starting: First of all, loosen bleeding screw on the fuel filter. Pump the fuel transfer pump by hand to bleed air in the fuel. Retighten the bleeding screw on the fuel filter.

Loosen bleeding screw on the injection pump. Repeat above procedure (see Fig 2-7, Fig 2-8 and Fig 2-9).

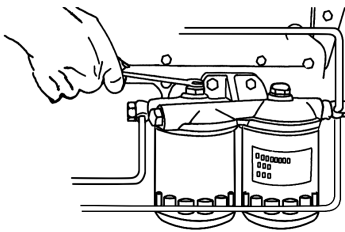

Fig2-7 Bleeding Diesel Filter

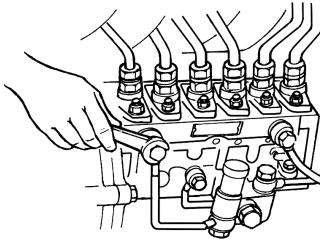

Fig2-8 Bleeding Injection Pump

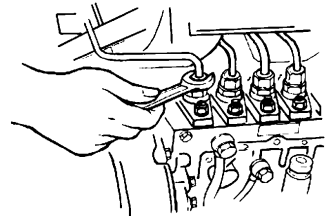

Fig2-9 Bleeding High Pressure Pipe

3.1.6 Check the tension of fan belt, electrical line connection and battery output.



3.1.7 For a new, or repaired turbocharged diesel engine or a turbocharged diesel engine stored for a long time, loosen oil inlet of turbocharger, add a little oil, tighten the screw, and then start the engine (see Fig 2-10).

oil inlet

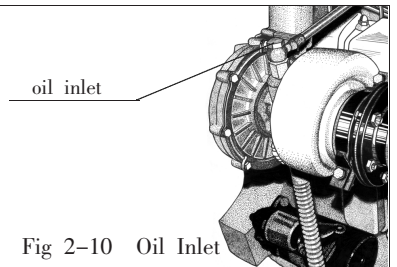

Fig 2-10 Oil Inlet

## 3.2 Starting the Engine



3.2.1 When starting the engine, do not try to approach these parts of engine, such as turning parts, front and back of moving parts, which could make you injury.

Do not start the engine by using short circuit method.

3.2.2 Before starting the engine, move the transmission control to NEUTRAL.

3.2.3 Move the fuel pump rack approaching maximum position and leave the shut off hand lever at fuel supply position.

3.2.4 Turn on the power switch. Push down the start button to start the engine. When the ambient temperature is below  $-10^{\circ}\text{C}$ , for the engine with preheating function, press air preheat button to preheat the engine for about 30 seconds, and then the engine can be started easily.



3.2.5 The time of startup must be restricted in 10 minutes to prevent the starter and battery. The interval of each startup is 1–2 minutes. If the engine can not start over 3 times, find out the causes and correct them before starting the engine.

## 4 Operating the Engine

4.1 After the engine is started, put the fuel pump rack at the position of idle speed. Be sure that the oil pressure is not less than 98kPa.

4.2 After the engine is started, do not operate the engine at full load immediately. Let the engine run at middle speed in order to preheat it. Do not let the engine operate at full load and maximum speed until the coolant temperature is up to  $60^{\circ}\text{C}$ .

4.3 During the engine operation, always check engine oil pressure and coolant temperature regularly. At normal ambient condition, the coolant temperature should be about  $75^{\circ}\text{C}\sim 90^{\circ}\text{C}$  and the oil pressure 294 kPa to 490 kPa . However when oil temperature is  $95^{\circ}\text{C}$  to  $100^{\circ}\text{C}$ , the oil pressure could be a little bit lower than 294 kPa.

4.4 When operating the engine, pay attention to any abnormal noise and look for leakage at the connection of fuel pipes, water pipes and air pipes. If any encountered, remove it immediately.



4.5 When the engine runs away, cut off fuel supply or choke the air intake system in order to stop the engine (see Fig 2-11).

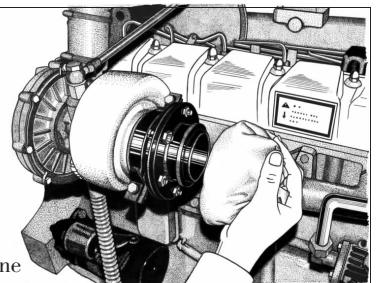

Fig2-11 Stop the Engine





4.6 Do not let the engine run at the idle speed over 10 minutes. This will cause the failure of injection system.

4.7 When the ambient temperature is below  $-10^{\circ}\text{C}$ , do not let the engine run at the high speed immediately after the engine is started.

4.8 Do not run the engine when the oil pressure is less than 98 kPa. If it happens, find out the causes and correct them immediately.

4.9 Do not let the engine run continuously when the coolant temperature is lower than  $60^{\circ}\text{C}$  or above  $100^{\circ}\text{C}$ .

## 5 Stopping the Engine



5.1 After operating under heavy load condition, allow the engine to idle for approximately 3 to 5 minutes prior to stop the engine.

5.2 In order to avoid air entering fuel supply system, do not stop the engine by turning off the fuel tank switch.

5.3 When the ambient temperature is below  $5^{\circ}\text{C}$ , for the engine without antifreeze coolant, drain the cooling water when the cooling water temperature is at  $40^{\circ}\text{C}$  to  $50^{\circ}\text{C}$ . Open one by one the water drain cocks on radiator, cylinder body and oil cooler. And then let all cooling water off.

5.4 Maintain the engine according to the instructions if the engine is to be stored for a long period of time.

## 6 Running in

6.1 For a new engine or repaired engine, Run in the engine gradually to improve working capability of the engine before operating the engine. After running-in the engine, its functional reliability and usage life will be improved obviously.

6.2 With the engine running-in, the following procedures should be complied with.

6.2.1 Warm up the engine at light load and mid-low speed in order to make coolant temperature up to  $60^{\circ}\text{C}$ .

6.2.2 Idling the engine not over 10 minutes.

6.2.3 Often observe coolant temperature and oil pressure, keep them in normal ranges.

6.2.4 Check the levels of coolant and lubrication, keep them in normal ranges.



6.3 The running-in hours of YTO LR-R, A, B, M, N series engines is not less than 60 hours. Run-in the engine in proper sequence according following tables (Tab 2-3).

Table 2-3 (1) Engine Running-in Procedure (Three Circles)

| Load(%) | Speed(%) | Hours/min | Load(%) | Speed(%) | Hours/min |
|---------|----------|-----------|---------|----------|-----------|
| 25      | 70       | 60        | 75      | 80       | 150       |
| 50      | 70       | 120       | 90      | 80       | 30        |

Table 2-3(2) Engine Running-in Procedure (Five Circles)

| Load(%) | Speed(%) | Hours/min | Load(%) | Speed(%) | Hours/min |
|---------|----------|-----------|---------|----------|-----------|
| 50      | 80       | 60        | 90      | 90       | 150       |
| 75      | 80       | 120       | 100     | 90       | 30        |

Table 2-3(3) Engine Running-in Procedure (Two Circles)

| Load(%) | Speed(%) | Hours/min | Load(%) | Speed(%) | Hours/min |
|---------|----------|-----------|---------|----------|-----------|
| 50      | 100      | 60        | 90      | 90       | 150       |
| 75      | 100      | 120       | 100     | 100      | 30        |

6.4 When engine matches with automobile vehicles, running-in the engine according to the vehicle running-in procedure. Total running-in mile is not less than 2 500 km.

6.4.1 Not more than 50% load, running is 800 km, running velocity is less than 70% corresponding the engine speed.

6.4.2 Not more than 75% load, running is 1500 km, running velocity is less than 75% corresponding the engine speed.

6.4.3 75% load, running is 1 500 to 25 000 km, running velocity is less than corresponding the engine rated maximum speed.

6.5 After running-in, clean and check the engine according to the following procedure (please read relative contents in the maintenance manual carefully).

6.5.1 Change the oil, replace the oil filter elements, and clean the oil sump.

6.5.2 Change the diesel fuel filter element.

6.5.3 Check and adjust valve clearances and fuel supply advance angles. Tighten all the bolts and nuts (see chapter 5).



Do not operate the engine at full load without running-in. This will shorten the engine useful life.

## Chapter 3 Maintenance

### 1 Technical Maintenance

Considering that the engine is used under normal working conditions, the maintenance intervals stipulated are determined. When working in extremely adverse conditions, it is recommended that the planned maintenance should be executed at shorter intervals.

Maintenance intervals stipulated are divided into four maintenance periods.

- 1.1 Daily Maintenance: Every 8 to 10 hours.
- 1.2 Class I Maintenance: Every 50 hours (about 2000 km for vehicles).
- 1.3 Class II Maintenance: Every 150 hours (about 6000 km for vehicles).
- 1.4 Class III Maintenance: Every 900 to 1000 hours (about 35000 km for vehicles)



For the turbo-charged and turbo-charged with intercooler diesel engines, the period should be shortened by 20%

### 2 Daily Maintenance (After 8 to 10 hours)

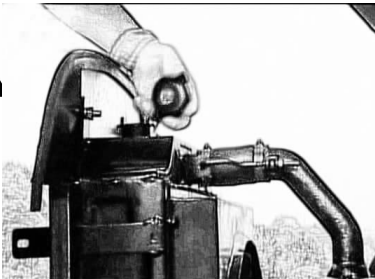

2.1 Before starting the engine every day, check whether the oil level in oil sump and injection pump without pressurized lubrication is correct. Refill the oil if necessary. Pay attention to check whether there is water in oil.

2.2 Check the coolant level in the radiator, refill them if necessary (see Fig3-1).



2.3 Clean sundries and dust on radiator grille. Remove the dust and oil outside the engine. For the engine used for tractors, do clean them at any time (see Fig3-2).

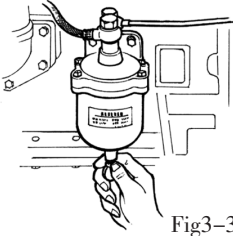

2.4 Drain the water from filter element with drain cock, and sedimentation filter (see Fig 3-3).

Fig3-3 Drain the Water



2.5 Check and retighten all fastening screws. Correct any fuel, water gas leak found (see Fig3-4).

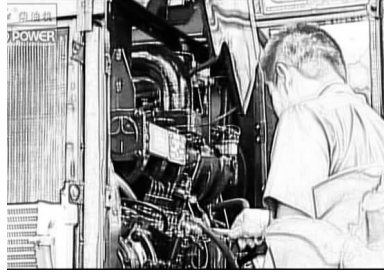
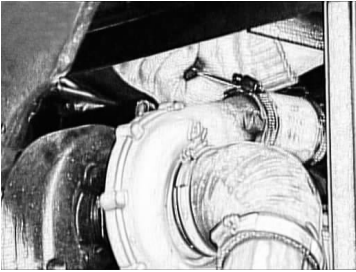
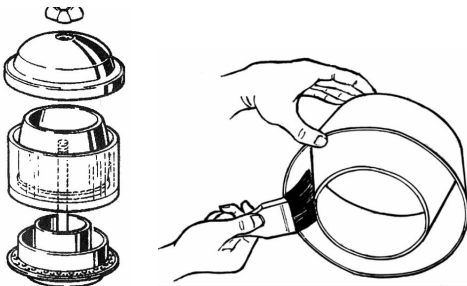

Fig 3-4 Check the Leaks

2.6 Air Cleaner

2.6.1 Clean the dust accumulator of oil bath air cleaner.



2.6.2 Clean the drain valve of dry air cleaner.

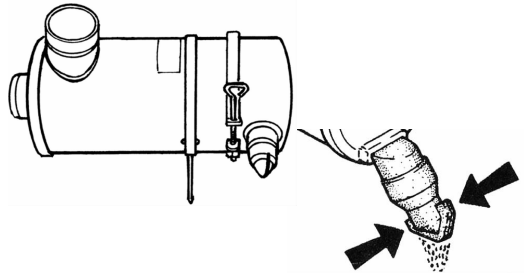

For the engines under the special conditions, cleaning time should be shortened. Recommended cleaning time is listed in Table 3-4.

Table 3-4 Recommended Cleaning Time

|  |               |
|--|---------------|
| Harvesters   | Every 4 hours |
| Tractors   | Every 6 hours |
| Construction machinery working in mines with more dust | Every 4 hours |
| Machines working in general condition                  | Every 8 hours |

### 3 Class I Maintenance (after 50 hours)



3.1 Perform all the items in Daily Maintenance.



#### 3.2 Clean dry air cleaner

Do not wash the dry paper filter element with water, diesel oil or gasoline. Be careful not to touch the paper filter element, and sealing ring should not forget to be installed in order to avoid air filter damaged. For the air cleaner with safety filter element, do not remove the safety filter element during operation and maintenance so as to avoid excessive wear due to broken main element. Replace the main element immediately when finding it out broken (including safety filter element).

3.2.1 All the junction parts of dry oil filter must be reliable. Do not go on working when any breakage happens.

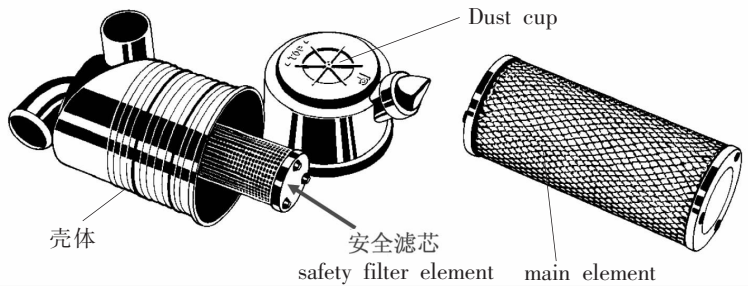

3.2.2 Clean the dust accumulator of air cleaner (see Fig3-5).

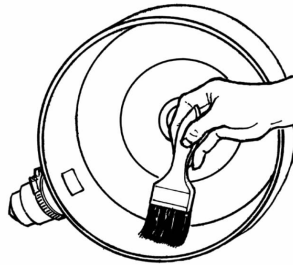

Fig 3-5 Clean Dust Accumulator

3.2.3 The filter element can be cleaned by finger tapping the upper and lower covers. Clean the dust on filter element with brush, or use compressed air along the pleats to blows the dust from inside to outside, and then from outside to inside, and finally from inside to outside (see Fig 3-6).

The filter element installation sees section 4 in chapter 3



Fig 3-6 Clean Air Filter Element

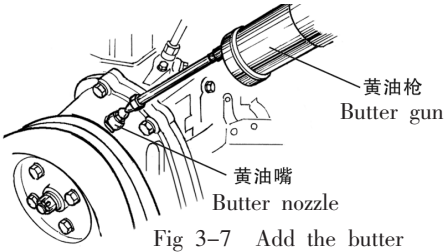

3.3 Add the butter of 15g to water pump bearing (see Fig 3-7). For maintenance free water pump, does not add the butter.

Fig 3-7 Add the butter



Running the engine with failure is prohibited. Pay a special attention to observe and hear abnormal noise and vibration, and watch whether the smoke color is normal. If finding out the failure, correct them immediately.



3.4 Measure the degree of tightness of fan belt. Press the belt between water pump and generator by hand. The deflection should be 10-20mm. Adjust belt tension if necessary by changing the position of the generator (see Fig3-8). Do not use the new and old one or different brands together.

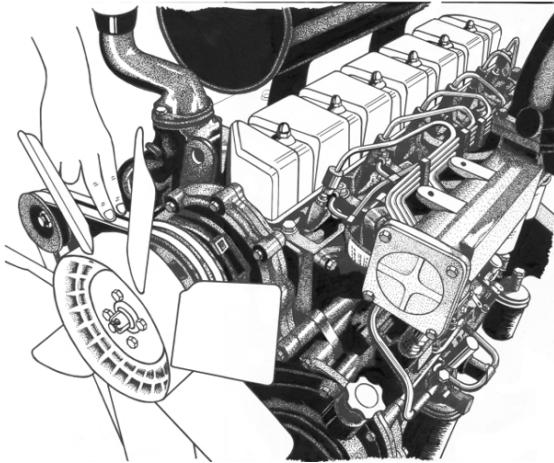

Fig 3-8 Check Belt Tension



3.5 For the first Class I Maintenance of a new or overhauled engine, change the lubrication, and clean the oil sump and air filter. Check the torques of main bolts and nuts. Check and adjust valve clearances and fuel supply advance angles. For details, please see section 4 and 5 of chapter 3.

#### 4 Class II Maintenance (after 150 hours)



4.1 Perform all the items in Class I Maintenance.



4.2 Warm up the engine until the oil temperature reaches 50~60°C. Unscrew the oil drain plug to drain the oil (see Fig3-10). Add cleaned diesel oil to clean the oil sump, and then drain them. Refill new oil after tightening the screws.

Fill the new lubrication.

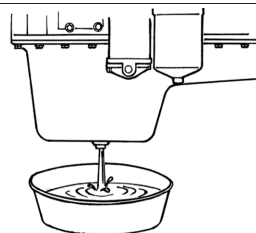

Fig 3-10 Drain the Oil



The used oil should be properly dealt to prevent pollution of the environment.

Pay attention to prevent hot injury by hot oil when adding.



Do not mix the new oil with old oil or different brands oil together.



4.3 Replace diesel fuel filter element: remove single use filter element with special tools (see Fig3-11). Before installing new filter element, daub a thin coat of oil on the sealing ring, then fix with the unloading torque.

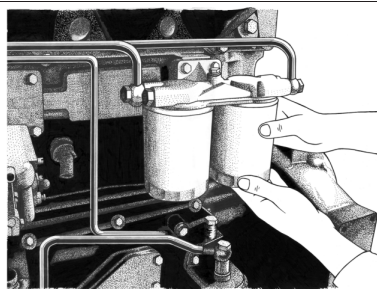

Fig3-11 Replace Diesel Fuel Filter Element



4.4 Replace spin-on oil filter element; remove oil filter with special tools. Daub a thin coat of oil on the sealing ring of new filter, and install new filter until the filter can be firmly connected with the sealing ring (see Fig3-12). For some filters with paper filter element, filter element is only replaced.



Fig3-12 Replace Oil Filter Element

#### 4.5 Clean air filter

##### 4.5.1 Clean oil bath air cleaner

4.5.1.1 Change the oil in oil bath air cleaner. Add the oil to the specified level.

4.5.1.2 For oil bath air cleaner, wash the filter element assembly with diesel oil or kerosene until it is clean.

4.5.1.3 Marinate the filter element assembly with engine oil. Make the engine oil adhere to the filter element, and then install it.

##### 4.5.2 Replace filter element of dry air cleaner

4.5.2.1 Take out the old filter element. Clean the filter shell and its dust cup with clean wet cloth (see Fig3-13).

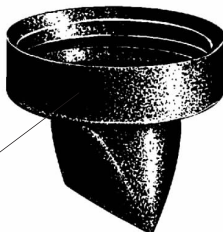
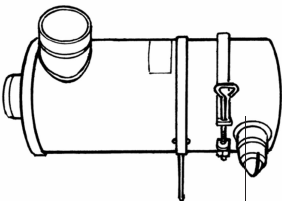

Fig3-13 Clean the Shell and Dust Cup



Fig3-14 Rubber Ring Installation

4.5.2.2 For a new filter element, check the elasticity and leak tightness of rubber ring. Press the rubber ring by hand, and make it reliably be connected to filter element (see Fig3-14).



Drain valve

Fig3-15 Drain Valve

4.5.2.3 After installing the filter element, check the drain valve. If any breakage occurs, replace it immediately (see Fig3-15).





4.6 Check the injection pressure and quality of sprayer (see Fig3-16). The opening pressure of J series fuel injection is 19.6 MPa to 20.8MPa. The opening pressure of P series fuel injection is 25 MPa to 26MPa. Clean the soot and adjust the pressure if necessary.

When nozzle is blocked, it must be replaced. It is suggested that all the jobs are finished by the professionals.

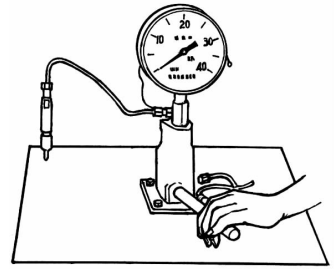

Fig3-16 Check the Injector



4.7 Check and adjust the fuel supply advance angle of the injector. For details, please see section 5 of charter 5.



4.8 Check and adjust the clearances of exhaust valve and intake valve. The clearance of intake valve is 0.3mm to 0.4mm, the clearance of exhaust valve is 0.4mm to 0.5mm. For details, please see section 2 of charter 5.



4.9 Check and tighten all screws and nuts with specified torques. For details, please see section 1 and 2 of charter 5.



4.10 Check the leakage of intake pipe and exhaust pipe of air compressor. Check and clean the dirt on the exhaust valve and intake valve. Check the leakage. Remove the faults. The profile of the air compressor sees Fig 3-17.

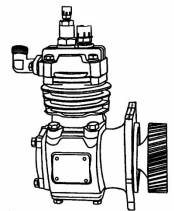

Fig 3-17 Air Compressor

### 5 Class III Maintenance (after 900 hours)



5.1 Perform all the items in Class II Maintenance.

If the users could not independently finish them, it is suggested that the Class III Maintenance jobs are finished by specialized agency.



5.2 Wash and Clean the Cooling System

The scale deposit in the cooling system can cause the cooling failure of diesel engine. Remove it regularly. The general method is that the detergent is poured into the cooling system to wash them. The detergent is mixed with 750g caustic soda and 150g kerosene. Washing the cooling system as fol-

lows: Fill the detergent into engine as coolant. Run the engine at middle speed for 5~10 minutes. Stop the engine. Restart the engine after making the detergent stay at the engine for 10~12 hours. Let off the detergent after running the engine at middle speed 15~20 minutes. let the engine run at middle speed 15~20 minutes after refilling the clean water. Drain the water in the engine.

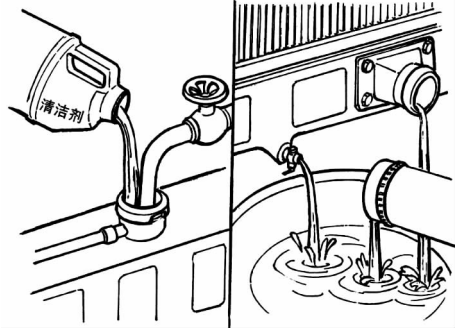

5.3 Remove the cylinder head. Clean the soot on the valve. Replace the valve oil seal (see Fig3-18).

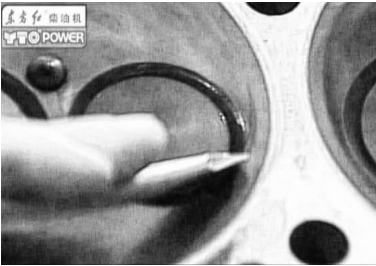

Fig3-18 Clean the Soot



5.4 Check if there is the cinch marks on the liner and piston. Check if the clearance of piston ring is correct (see Fig3-19).

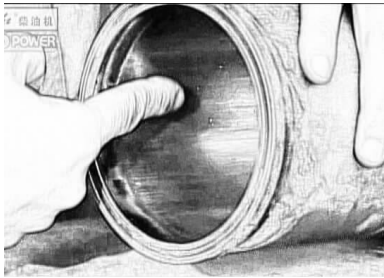

Fig3-19 Check Liner and Piston

5.5 Check crankshaft, main bearing and connecting-rod bearing shell. Replace it if the wear of cinch marks is bigger (see Fig3-20).

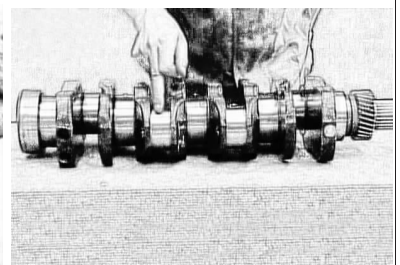
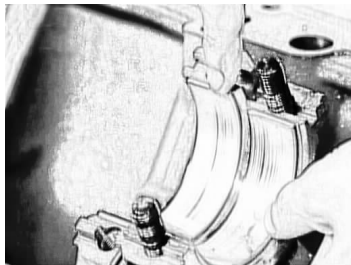

Fig3-20 Check Crankshaft, Main Bearing and Connecting-rod Bearing Shell



When performing the class III maintenance, if any part of the piston, piston ring, liner, main bearing and connecting-rod bearing shell has been replaced, do not operate the engine until rerunning-in the engine is finished completely according to the specified procedure.



5.6 Check water leakage of water pump. Change the water sealing of water pump as necessary (see Fig3-21).

For details, please see section 6 of chapter 5.

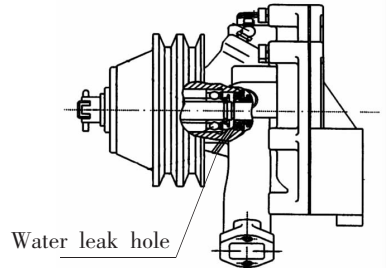

Fig 3-21 Check Water Leakage

## 6. Turbocharger



The turbocharger maintenances should be carried out with the engine maintenance.

### 6.1 Daily Maintenance

Tighten the connection between the turbocharger and the engine. Look for oil seepage and leakage gas, and correct them. Check if the cushion at the connection flange between the turbocharger and exhaust pipe is breakage. Replace it as necessary. Keep outside the turbocharger clean. The structure of the turbocharger sees Fig3-22.

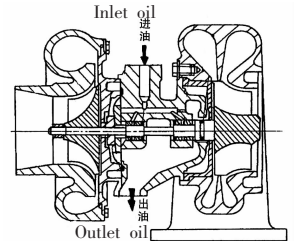

Fig 3-22

### 6.2 Turbocharger Regular Maintenance



The regular Maintenance of the turbocharger is performed when the Class II Maintenance of the engine is carried out.

It is suggested that the maintenance of the turbocharger is carried out by professionals.



Do not dismount and adjust the turbocharger by laypeople.

Do not allow something to go into the intake system and exhaust system when checking the turbocharger.



6.2.1 Replace filter element of the turbocharger: dismount oil filter with special purpose tools. Daub a little bit oil on sealing ring. And then make the new filter be installed firmly (see Fig3-23).

Turbocharger filter element

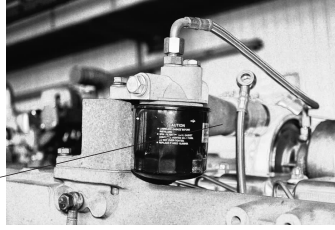

Fig3-23 Turbocharger Filter Element

6.2.2 Wash the intake connector pipes, compressor impeller and compressor shell. Clean the soot in the impeller and turbine casing.

6.2.3 Check the moving parts in the turbocharger. Turn the rotor moving with finger. If the rotor can move some revolutions by inertia force, it is considered moving flexible. If the rotor rotates roughly and knocking noise is heard, find out the cause and correct it.

6.2.4 Check the axial displacement of rotor shaft. If the axial displacement is more than 3mm, which shows that the wear of thrust bearing in the turbocharger is bigger, find out the cause and correct it.

6.2.5 Check the radial displacement between compressor impeller and casing. Press the impeller in radial direction by hand. If the displacement is over 0.1mm, find out the cause and correct it.

6.2.6 When the engine run at the idle speed, unscrew the oil drain connector of the turbocharger. Observe if the lubrication flows through the turbocharger. Check and reinstall it if necessary.

## 7 Maintenance in Winter Season

In winter season (ambient temperature below 5°C), it is difficult to start the engine due to the cooler engine block and stickier oil. The oil in the transmission system and running gears of tractors, vehicles and construction machinery will become stickier due to low temperature. This will cause higher resistance. Therefore, the engine operation and maintenance must be carried out more carefully when the engine runs at the low temperature



When the ambient temperature is below 60°C, do not let the engine run at the full load just after starting.

### 7.1 Cooling System

7.1.1 The engine should use coolant with antifreeze additives in winter season.

7.1.2 Before starting the engine without antifreeze additives, fill the cooling system with 60~70°C hot water ,and then with 90~100°C hot water until the water flowing out at the water drain cock. Fill the radiator with 60~70°C hot water, and then start the engine.

7.1.3 During operation, the coolant temperature should not be below 60°C. If the engine without antifreeze additives is to be stored for a long period of time, drain the cooling system when the coolant temperature reduces at the 50~60°C.

### 7.2 Lubrication System

Use winter lubrication oil in winter season. When the ambient temperature is below  $-10^{\circ}\text{C}$ , turn on the switch to preheat the engine for about 30 seconds before starting.

### 7.3 Fuel Supply System

Use winter fuel in winter season. Keep rain, snow or dirt away from entering fuel system. If the water in the fuel tank is found out, drain the fuel system completely to prevent fuel line choked due to freezing. Refill the fuel tank with new fuel.

## 8 Storage and Maintenance

Use the following procedures to store the engine for over 3 months.

8.1 Turn the crankshaft several revolutions so that the surface of moving parts are equably coated with oil film.

8.2 Drain out the fuel, oil and coolant, including the oil in the injection pump, oil bath air filter.

8.3 Remove the trash, dust and rust outside the engine. Smear anti-rust oil on the unpainted parts and jointed points.

8.4 Plug the air intake, exhaust port and oil filler to prevent something entering the engine.

8.5 Store the engine in dry, clean and good ventilation place. There are no corrosive gases nearby. If the engine is stored outside, cover it with plastic sheet.



For a long period of storage, make a through examination, and run the engine at middle speed and accelerator for 3 to 5 minutes every half a year so as to maintain the moving parts with oil film. Restore the engine with specified requirements.

## Chapter 4 EUP Fuel Injection System Operation Instruction

EUP fuel injection system is a pump-tube-nozzle time controlled fuel injection system, which consist of sensors, harness components, electronic control unit (ECU) electronic unit-pump (EUP) assembly, high-pressure oil tubes and injector. This system can realize flexible control of fuel injection quantity and fuel-injection timing.

### 1 System Constitution (see Fig 4-1)

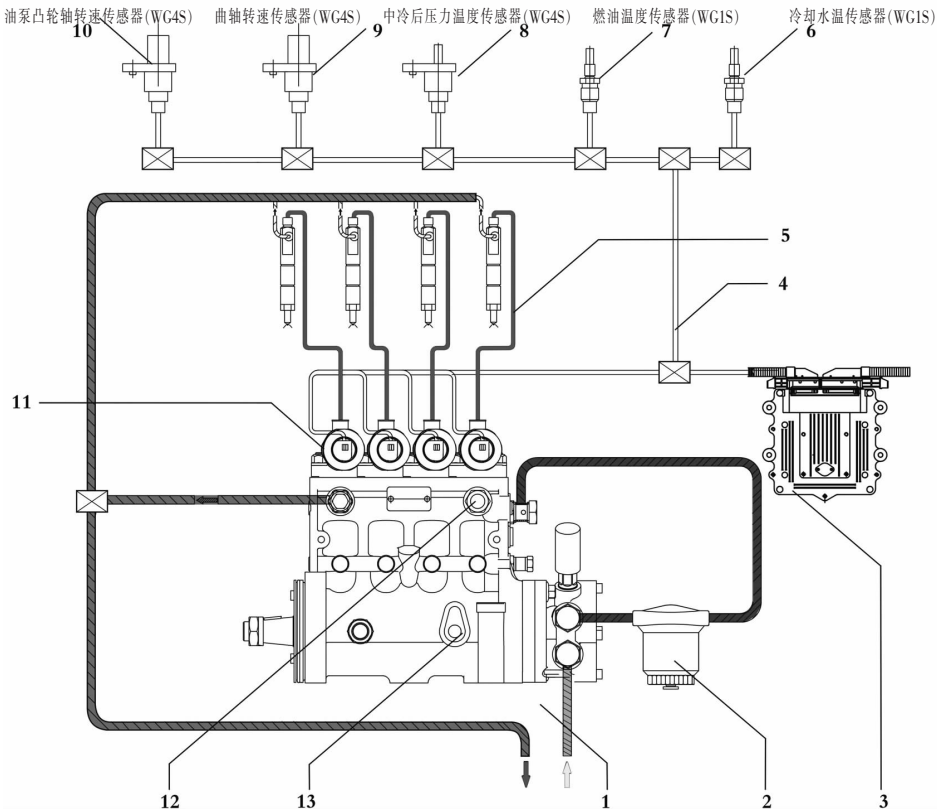
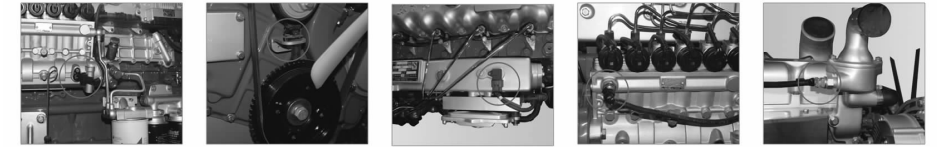

- |  |   |  |
|--|---|--|
| 1. Electronic compound pump assembly   | 6. Water temperature sensor (WG1S)                      | 11. Electronic injection unit                        |
| 2. Diesel fuel filter                  | 7. Fuel temperature sensor (WG1S)                       | 12. Oil temperature sensor interface at side of pump |
| 3. ECU control unit                    | 8. Pressure/temperature sensor after intercooler (WG4S) | 13. Oil temperature sensor interface of oil pump     |
| 4. Wiring harness assembly             | 9. Speed sensor of crankshaft (WG4S)                    |  |
| 5. High pressure oil pipe and injector | 10. Speed sensor of injection pump camshaft (WG4S)      |  |

Fig 4-1 Diagram of System Constitution

## 2 Each Part Function and Sensor Installation Position

### 2.1 Diesel engine crankshaft speed sensor

Pulley speed sensor installed on the client side or the flywheel from the ECU to the current diesel engine speed determination (see Fig4-2).



Fig 4-2

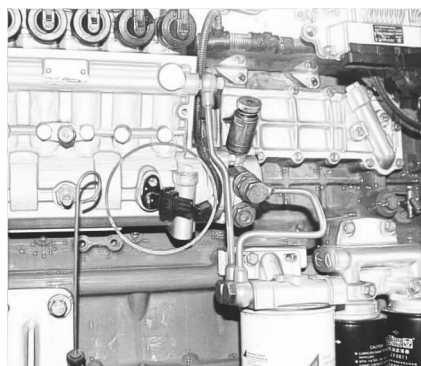

Fig 4-3

2.2 Measure the speed of oil pump cam shaft with ECU. Model number: MG4S (see Fig4-3).

### 2.3 Oil temperature Sensor at the side of Oil Pump

The oil temperature sensor is installed at the side of oil pump. The fuel temperature at the side of oil pump is detected by ECU. Model number: WG1S (see Fig4-4).

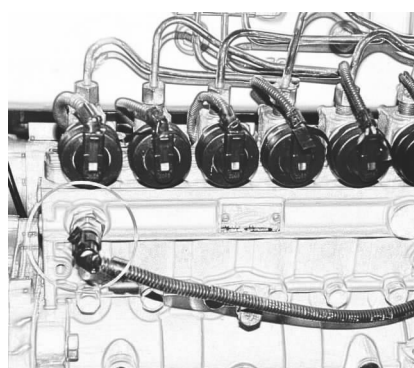

Fig 4-4

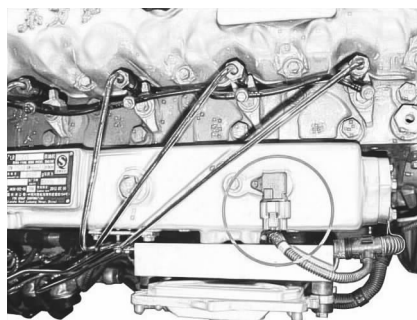

Fig 4-5 Pressure/temperature Sensor after Intercooler

2.4 Pressure/temperature Sensor after Intercooler

The pressure/temperature sensor is installed on the intake pipe. The air temperature and pressure after intercooler are detected by ECU. Model number: YWG1S (see Fig4-5).

### 2.5 Water Temperature Sensor

The coolant temperature sensor is installed on the cooling watercourse or radiator housing, which is used for measuring coolant temperature of the engine. Model number: WG1S (see Fig4-6).

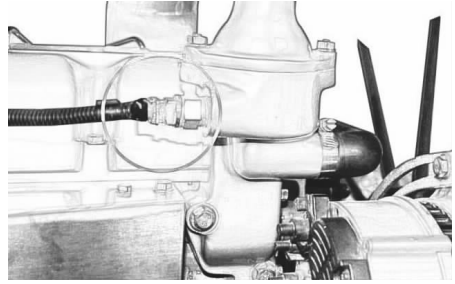

Fig 4-6 Water Temperature Sensor

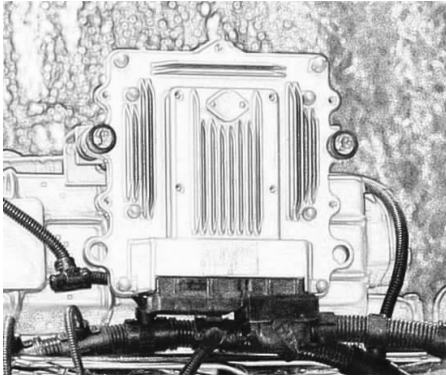

Fig 4-7 ECU Control Unit

### 2.6 ECU Control Unit

ECU has 121 core standard socket which has error-proof function. 81 core patch plug is connected with the accelerator, detecting Instruments, communication serial port and vehicle power in cab by using wiring harness. 40 core patch plug is connected with sensors of electrical system and every cylinder injection unit of electric pump by using wiring harness (see Fig4-7).

### 2.7 Electronic Unit Pump Assembly

Each cylinder injection unit of electric pump is connected with ECU by using the control wire of wiring harness. For four cylinder engines, wiring harness component consists of 8 control wires, for six cylinder engines, wiring harness component consists of 12 control wires. Each group of two is installed in the plug, which is connected with injection unit of each cylinder electromagnet. The red wire in each group is connected to the control wire of each cylinder solenoid valve, the gray wire in each group is public end (see Fig4-8).

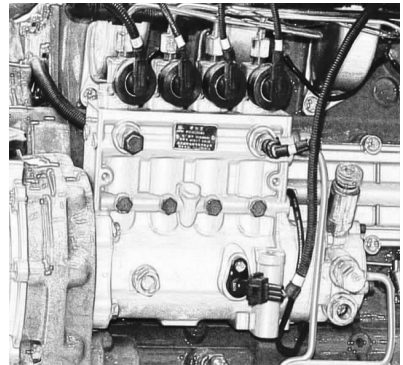

Fig4-8 Electronic Unit Pump Assembly

### 2.8 Wiring Harness Component

The engine control Harness is connected to 40 core standard socket which has error-proof function in ECU through 40 core standard plug, at the same time, which is also connected with the sensors of electric system and electric injection unit of each cylinder (see Fig4-9).

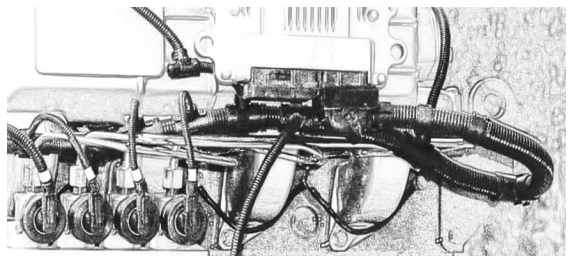

Fig4-9 Wiring Harness Component



### 2.9 Low Pressure Oil Transfer Pipes and Diesel Fuel Filter

2.9.1 Low pressure oil transfer pipes: Low pressure oil transfer pipes use enough strength and performance non-metal pipes to connect oil tank, oil transfer pipes and diesel fuel filter.

2.9.2 Because only high cleaning fuel is used for electronic fuel injection system, so the engine uses filter with high filtration capacity, which can not be replaced by common filter.

### 2.10 High Pressure Oil Pipes and Injector

2.10.1 High pressure oil pipes: high pressure oil pipes used in the system are special purpose parts. The pressure resistance index of high pressure oil pipes is higher than that of general ones because the system is a high pressure injection system. Specified high pressure oil pipes can not be replaced by ordinary ones.

2.10.2 Injector: the injector used in the system is determined by special design and the engine test bed match calibration experiment, and its parameters, such as opening pressure, injection hole numbers, flow and spraying angle must be in conformity with the specified requirements so as to meet the performance and emission of the engine. Therefore, the injector is made from special materials and techniques, although its shape is similar to general injector, but it can not be replaced by ordinary injector. The key parameters of the injector are as follows:

Hole number: 7 × 155°    Opening pressure : 25 MPa~27MPa

## 3 System Operation

### 3.1 Check-up before Operation

3.1.1 Lubrication: API CF grade or CF above engine oil should be used. Make sure the level at the middle of the dipstick.

3.1.2 Diesel: add the diesel fuel that must meet China Standard: GB-252. For ambient temperatures, relative grade diesel fuel must be used.

3.1.3 Coolant: add the coolant level as specified demand.

3.1.4 Keep the connector tubes of air filter and turbocharged intercooler system without leakage.

### 3.2 Bleeding Low Pressure Pipes and Injection Pump Body.

For a new engine or an engine stored for a long period, use the following procedures to bleed the low pressure pipes and injection pump body before starting: Open the oil tank switch and bleeder screw on the fuel filter. Turn the handle of hand pump anticlockwise to make the handle release. Press the handle to bleed air in low pressure pipes. Close the bleeder screw. Loosen the high pressure pipe connector at the pump one by one. Press the handle until the oil flows out from high pressure pipe. Screw down high pressure pipe. Press the handle back. Tighten it up clockwise.



CF4 grade or above CF4 grade engine oil must be used  
Oil pump should be full with oil before starting to prevent the oil pump from being damaged.

### 3.3 System Inspection

After above items meet the request, start the engine. First of all, turn the power on and turn the ignition key to the first gear and this means the system is switched on. When ECU is switched on, the system is automatically detected by ECU. No matter whether the system is in trouble, the trouble lamp on the instrument panel will forced light up for 4 seconds. If the trouble lamp does not light up after 4 seconds, this means the system is in normal condition. Start the engine.

After 4 seconds, if the trouble lamp goes into blink slowly, this means there are common faults in the system. If the trouble lamp goes into blink fast, this means there are serious faults in the system. Starting the engine is prohibited in above two conditions. Turn the power off, look for the causes and correct them. After the power is turned off, the system is detected until normal condition.

After the power is turned on, the trouble lamp does not light up, this means that trouble lamp has been damaged or the wiring is in trouble. Do not start the engine, and find out the causes and correct them



Do not start the engine when the trouble lamp blinks slowly, fast or is inoperative.



When above faults happen, please contact your local dealer or professional maintenance staff, and correct them.

### 3.4 Normal Operation

3.4.1 During the operation, the trouble lamp on the instrument panel slowly or fast blinks, stop the engine, find out the causes and correct them and then let the engine start and run again.

3.4.2 For other details, please see chapter 2 **Engine usage**.

## 4 Maintenance

4.1 Check the pump assembly and make sure the seal without oil leakage after running-in the engine.

4.2 Combining the engine Daily Maintenance, check the leaks between WP2000 pump assembly and the engine, and bolt tightness.

4.3 Combining the engine Class II Maintenance, check the tightness of set bolts, electromagnet bolts and binding screws in WP2000 pump assembly.

4.4 Connect the solenoid plug well to avoid short circuit. If leakage, crack and short circuit in the electromagnet occur, replace with a new one. The pre-tightening of electromagnet rear cover is 40~45N·m.

4.5 For harness, if these faults occur, such as poor quality electrical connection, scratch in insulating layer and crack caused by excessive curve and extrusion, replace it in time.

4.6 Fuse: 15A fuse, supply 24V power to electromagnet though whole vehicle battery and main relay; 3A fuse, supply power to the ECU Internal circuit.



Changing fuse Specifications is prohibited.



4.7 Before other operation with power-on (such as welding), turn off ECU supply power circuit (disconnect the battery positive electrode), and separate ECU from the engine or vehicle.



4.8 Never swash the ECU and harness directly with high pressure gun when cleaning and maintaining.

4.9 Never dismount or replace the pump assembly or its parts by people who are not from the manufacturer or professionals specified by the manufacturer.

4.10 The waterproofing treatment of ECU controller is done. When fault happens, opening ECU is not prohibited by customers, please send it to the maintenance points specified by the manufacturer.

4.11 Maintenance and operation with charged condition is prohibited. Turn the power off during maintaining.

4.12 For Other maintenances, please see chapter 3 **Maintenance**.

## 5 Fault Diagnosis

During the engine and vehicles operation, the fault may occur to each component in electronic-controlled fuel injection system. When any fault occurs, the engine works abnormally. Some faults can make the engine misfire. ECU not only can write down automatically the faults happened, and but also can indicate the current fault state of diesel engine to driver or maintenance staff through the fault indicator so as to operate and maintain vehicles.

5.1 Fault information is divided into two parts:

5.1.1 General fault level: breakdown is in water temperature sensor, oil temperature sensor, temperature pressure sensor after intercooler. When these faults occur, the engine can work normally through the treatment of control system, but this will influence the power and emission performance of the engine at a certain extent.

5.1.2 Serious fault level: there are the faults in the system which worsen the engine running and even make the engine stop, such as injection faults, abnormal speed signals of crankshaft or camshaft, etc.

### 5.2 Fault Code

5.2.1 Fault codes are encoded by using the SAE International Standards, which is combination of four Arabic numerals, and stands for the specific fault. But the customers can not understand the code, please contact the manufacturer to diagnose and read them by professionals through connecting the display terminal with diagnosis interface. And correct them.

5.2.2 Diagnosis Interface: it is used for the whole vehicle calibration and fault diagnosis. In general condition, the diagnosis interface is connected with the wiring harness of the whole vehicle, and then installed on the instrument panel. The vehicle wiring harness supplies the power to diagnostic interface, and a standard RS-232 communication port. When the computer is monitoring the system or diagnosing the faults, the communication port of harness is connected with the computer , RS-232 port of the fault diagnosis instrument or CAN port, and then the communication is done.



Without allowance, do not modify and adjust the electric control system by customers. When any fault happens, please contact the manufacturer or specialist agencies specified by the manufacturer, find out the causes and correct them. Otherwise, this will bring you a great loss.

For details about electric control system, please refer to the introduction manual supplied by whole vehicle manufacturer or electric control system manufacturer.

## Chapter 5 Main Components Installation and Adjustment



Because YTO YT-A、B、J、M series engines have many models, therefore, if internal parts of the engine need to repair or replace, please let the model on the nameplate into local dealers or servicers exactly.

For the engine maintenance, please consult the specialized agency and perform by professionals.

### 1 Cylinder Body and Crankshaft Connecting Rod System



Wash all the parts with diesel oil or kerosene, and keep away flame before installation

1.1 For some cylinders with piston cooling nozzle, when installing, the junction surface of the nozzle should be smooth so as to prevent pressure oil leakage. Tighten up the washer and hollow screw (see Fig 5-1).

Cooling nozzle

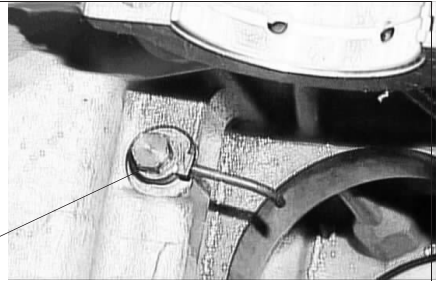

Fig 5-1 Cooling Nozzle

1.2 Opening pressure of the pressure limiting valve of oil pump: 680~700kPa for a four-cylinder diesel engine, 784±19kPa for a six-cylinder diesel engine. Do not adjust it. Lock firmly with iron wire after tightening (see Fig 5-2).

Pressure limiting valve of oil pump



Fig 5-2 Pressure Limiting Valve of Oil Pump

1.3 When installing main bearing, one with hole should be installed on cylinder block, other without hole should be on cover. Counted from rear end of crankshaft, the 2nd bearing bush is trust bearing, it should be installed in right position (see Fig 5-3).

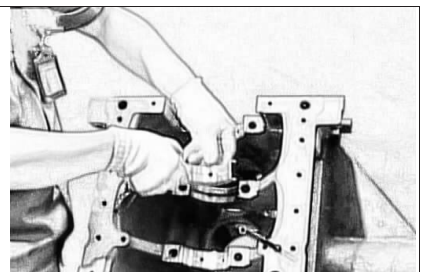
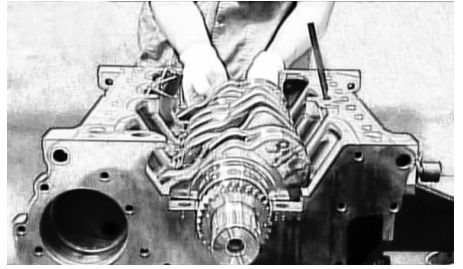

Fig 5-3 Main Bearing Installation

1.4 Before installing crankshaft, check screw plugs and tighten them firmly. Heat crankshaft gear to 100°C, then install it on front of spindle of crankshaft. Coat some oil on main bearings and connecting shafts, then install crankshaft into cylinder block (see Fig 5-4).



1.5 Pay attention to sequence number on main bearing cover before installation, arrow mark is toward front end of crankshaft, not let them in disorder. Tighten main bearing bolts starting from middle to each ends across two times, tighten torque is 201-206 Nm (see Fig 5-5).

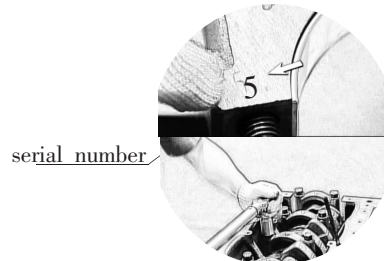

Fig 5-5 Main Bearing Cover Installation

1.6 There are four grooves around outside of wet block sleeves, among them, 1st, 2nd, 4th grooves are used for installing o-rings, 3rd one is leak groove, let this groove align with leak hole on cylinder block while installing sleeves (see Fig 5-6).



Fig 5-6 Leak Groove

1.7 Coat some oil on O-rings. Push sleeves into cylinder block by hands. If it is too hard, may use woodblock on sleeves, knock woodblock to let sleeves into its position on block. The head face of the sleeves should be 0.05-0.12mm tall above cylinder plane (see Fig 5-7)

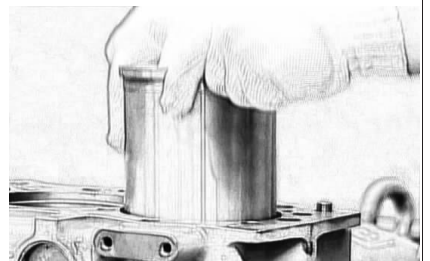

Fig 5-7 Wet Sleeves Installation

1.9 When installing connecting rods with piston, heat the piston to 100°C~120°C. if no heating condition, may put pistons into hot water, and boil it for 5~10 minutes.

1.10 Arrow mark on top of piston should align with forging mark on connecting rod side. Keep block ring into groove after installing piston pin (see Fig 5-9)



Without heating piston or knocking piston pin into piston is forbidden.  
For the same engine, weight grouping of the piston should bring into correspondence with that of connecting rods.

1.11 Oil ring is the 3rd of piston ring grooves, keep notch of oil ring separated with notch of supporting spring 180 degree. Make mark sides upward, if 1st and 2nd compression rings have a mark, it's doesn't matter for rings without mark. Notch of oil ring should avoid piston pin's, make notches of those three rings separated each other in 120 degree.



Fig 5-9 Piston and Piston Pin Installation

1.12 Coat some oil on piston and surface of cylinder sleeves before installing pistons, Use special tooling to install piston with connecting road assembly into sleeves, make arrow mark on top of piston faces to front end of crankshaft (see Fig 5-10).



Fig 5-10 Piston Installation

1.13 Before installing connecting rod bearing cover, coat some oil on crankshaft necks. Not mix connecting rod covers, keep group number consistently. Tighten (Tightening) torque of connecting rod bolts is 135 Nm (see Fig 5-11).



Fig 5-11 Connecting Rod Bearing Cover Installation

1.14 Use fixed pin to fix flywheel with crankshaft, crossly tighten bolts with torque 210 Nm (see Fig 5-12).

lywheel knock-pin

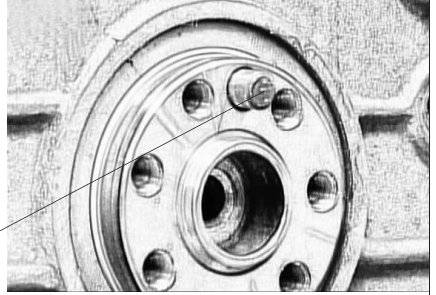

Fig 5-12 Flywheel Knock-pin



YTO-series engine adopted different connecting rods, before maintaining, please consult with local dealer to buy correct spare parts according to name plate on machine.



Group number of connecting rods should not be changed, same as group number of pistons. Connecting rods used on turbo-charger engine is not allowed to use general engine one's.

## 2 Cylinder head and Valve system

2.1 The YTO-series engines use united structure cylinder heads. Froze intake & exhaust valve seats into -180 degree liquid nitrogen, then install them into cylinder head (Fig 5-13).

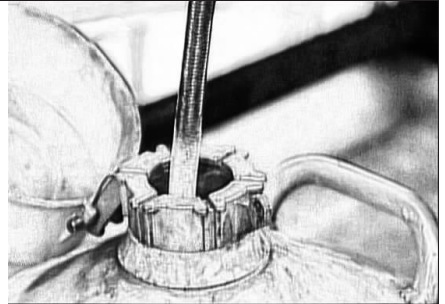

Fig 5-13 Freezing of Intake & Exhaust Valve Seats in Liquid Nitrogen

2.2 There are valve rotators on bottom of exhaust valve spring seat which makes valve rotation, improve valve seal and prolong use life (see Fig 5-14).

Valve-rotator

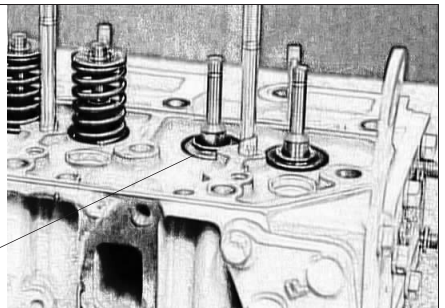
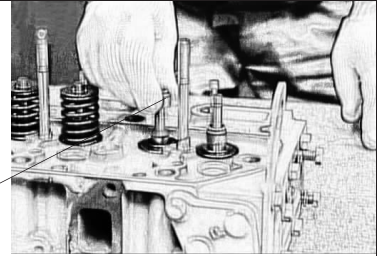

Fig 5-14 Valve Rotator



2.3 There are valve oil seals on valve stem which keep over oil into valve guide pipe. Make valve oil seals go into the correct position (see Fig 5-15).



Valve oil seal

Fig 5-15 Valve Oil Seal



2.4 The cylinder head gaskets (see Fig 5-16) which have non-asbestos one and full metal one are used in YTO series engines according to requirements. When maintaining, please chose and use the same gasket as original engine, and select the torques of cylinder head belts according to the corresponding engine model.

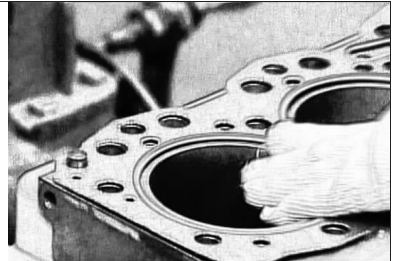
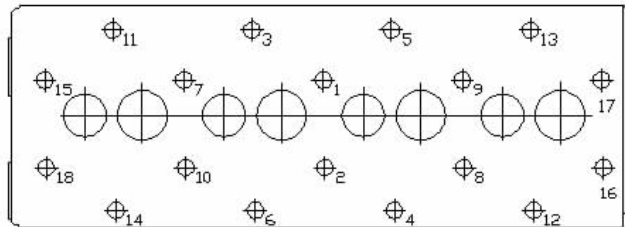
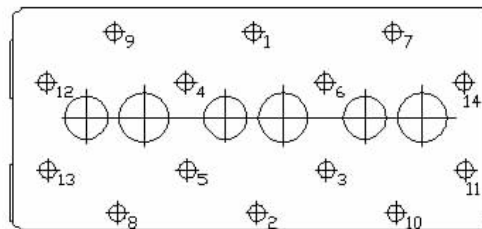
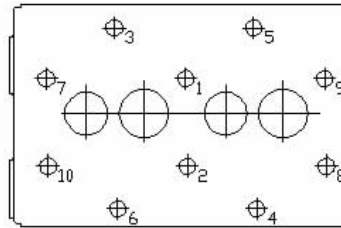

Fig 5-16 Cylinder Head Gasket

2.5 Tighten bolts from inside to outside crossly, first tighten to 80N.m, for the second time, firmly tighten them according to specified torque supplied in the mainte nance data table of chapter 7. Sequence for tightening cylinder head belts (see Fig 5-17).



2.6 Install the valve tappet and valve push rod. Please choose them correctly because valve tappet and valve push rod used in N series engines are different from others.

2.7 When installing rocker assembly, align oil hole on rocker arm seat with oil hole on cylinder head, and tighten bolts (see Fig 5-18).

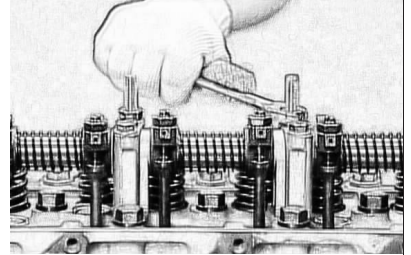

Fig 5-18 Rocker Assembly Installation

2.8 The valve sequence is; counted from front side of the engine, odd number is Intake valve, even number is exhaust valve. Intake valve clearance is 0.3~0.4mm, Exhaust valve clearance is 0.4~0.5mm (see Fig 5-19).

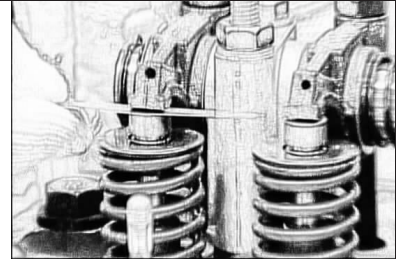

Fig 5-19 Valve Clearance Measured by Proof Stick

2.9 Adjusting method of valve clearance: turn crankshaft, when fuel appears on delivery port of first cylinder pump, stop to turn, at same time, all intake and exhaust valves are all closed (see Fig 5-20). Finger on flywheel ring should align with mark on flywheel housing.

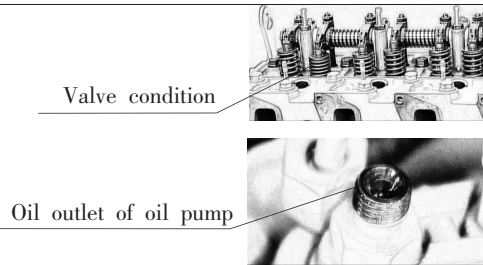

Fig 5-20 Valve Clearances Adjustment

- 2.10 (a) For two-cylinder engine counted from front side of the engine, adjust no.1,2,4 three valves.  
 (b) For three-cylinder engine counted from front side of the engine, adjust no.1,2,4,5 three valves.  
 (c) For four-cylinder engine counted from front side of the engine, adjust no.1,2,3,6 three valves.

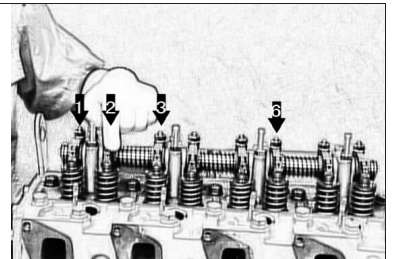

Fig 5-21 Valve Clearances Adjustment for Four-cylinder Engine

2.12 After above adjustment, turn crankshaft one revolution, adjust other valves clearances. After finishing all valves adjustment, recheck valve clearances as same sequence to keep correct valve clearances (see Fig 5-23).

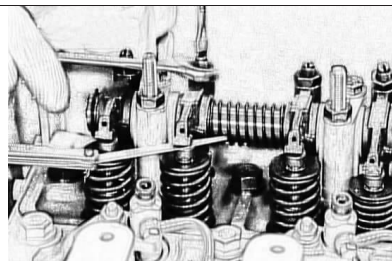

Fig 5-23 Check Valve Clearances

2.13 The lubrication in the gear system adopts pressurized lubrication. When installing lubricating pipes, pay attention to make the hollow screw tighten firmly (see Fig 5-24).

lubricant pipe of gears system



Fig 5-24 Lubricating Pipes Installation

2.14 Before installing the camshaft, coat a little bit oil on the bearing of support hole. Turn the camshaft into cylinder block. The thrust of camshaft depends on front thrust plate, so tighten bolts of thrust plate firmly (see Fig 5-25).

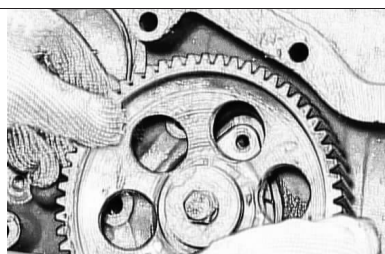

Fig 5-25 Camshaft Installation

2.15 Opening and closing of Intake valves and exhaust valves and fuel supply time are determined by timing gear system. When installing, align the mark on the idle gear with that of camshaft gear, injection pump gear and crankshaft gear, and tighten screws firmly (see Fig 5-26).

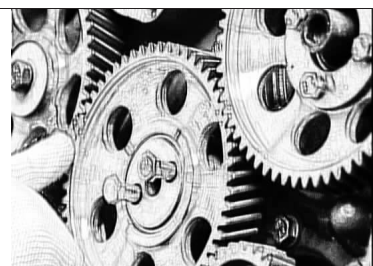

Fig 5-26 Timing Gear System Installation

2.16 In order to reduce vibration and noise, YTO series four cylinder engines adopt double-shaft balance mechanism, and its cylinders are different from general cylinders. The gears on the Left balance shaft are not same as that on the right balance shaft, and install them correctly. Oil channel through the hollow pin connect with cylinder oil channel. Before installing balance shafts, coat right amount oil on every journal of balance shaft, then put balance shafts into cylinder block, and fix locking plate on the cylinder (see Fig 5-27).

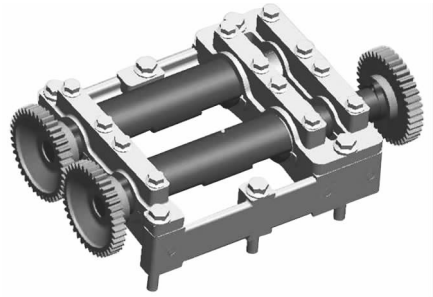
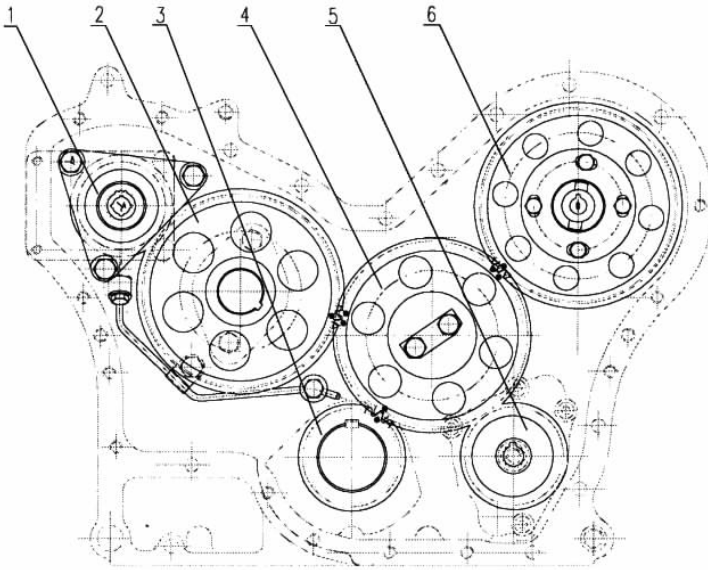

Fig 5-27 Double-shaft Balance Mechanism



- 1. Hydraulic pump gear
- 2. Camshaft gear
- 3. Crankshaft gear
- 4. Idle gear
- 5. Oil pump gear
- 6. Injection pump gear

Fig5-28 Gears System with Double-shaft Balance

### 3 Turbo-changer and Intercooler System

3.1 The full floating bearings are used in the turbocharger. The rotor assembly is mounted on the middle housing. The pressurized lubrication flows through the middle housing to lubricate and cool the bearings. When the turbo-changer is working, its skin temperature is above 400°C. Rotate speed of the impeller is up to 80000 ~ 120000r/min. After the air flows through turbocharger, the air is pressurized and the temperature is also increased to 70~140°C. Therefore, turbo-charged system should be lubricated, and its seal should be very reliably; only clean air and lubrication can make the engine work normally.

### 3.2 Turbocharger

3.2.1 Install turbocharger on exhaust manifold, Put gasket in right place, and tighten bolts (see Fig 5-29).

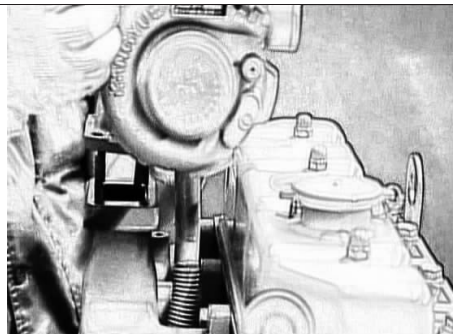

Fig 5-29 Turbocharger Installation

3.2.2 Connect oil return pipe of the turbo-charger well, Makes it thoroughly (see Fig 5-30).

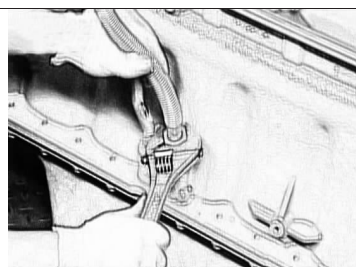

Fig 5-30 Oil Return Pipe of Turbo-charger

3.2.3 When installing oil inlet pipe, add suitable oil into oil inlet of turbo-charger, then tighten oil Inlet pipe (see Fig 5-31).

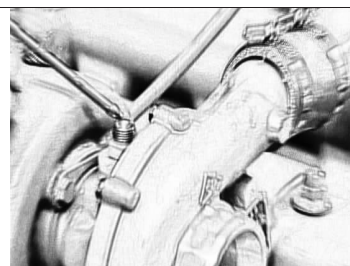

Fig 5-31 Turbo-charger Oil Inlet Pipe Installation

3.2.4 Keep the connecting tube of inlet intake and exhaust pipe well without broken. Tighten up with clip see Fig 5-32).

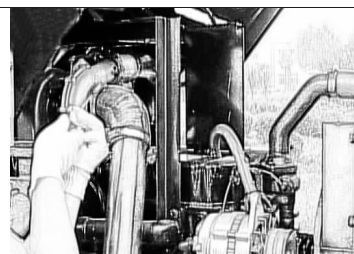

Fig 5-32 Connecting of Intake and Exhaust Pipes



### 3.3 Main usage points for turbocharger

3.3.1 For a new or repaired turbocharger, turn the rotor with hand, move gear freely without block and abnormal noise.

3.3.2 Start the engine alternatively 2~3 times by 3~5 seconds each times in order to make floating bearing of turbocharger fill with oil. After the engine is started, let the engine run at idle speed several minutes. Do not increase the speed until the turbocharger bearings are enough lubricated. Pay attention to this in cold winter.

3.3.3 Do not shut off the engine suddenly when the engine is running. After stopping the engine, let the engine run at middle speed for several minutes. Reduce the speed gradually, and stop it.

3.3.4 API CF grade or CF above engine oil should be used. Replace filter element as specified interval time.

3.3.5 Stop the engine, and find out the causes when oil pressure is less than 0.2 MPa.

3.3.6 Clean the air cleaner in time in order to prevent filter breakage or too big resistance, and make sure the intake system is leakproof.



Continuing to operate the engine is prohibited after air inlet pipes in the turbo-charged system is breakage

Do not dismount and adjust the turbocharger by laypeople.

### 3.4 Inter-cooling System

YTO series engines use air-air, water-air intercooler technologies to cool the compressed air from the turbocharger. The air-air intercooler is installed in the front of the radiator and cooled by the air sucked by the radiator fan and wind facing the traveling vehicle (see Fig 5-33). The temperature of intake air from the intercooler is reduced greatly so that the dynamic and economic performances of the engine are all increased and emissions and heat load of the engine are improved.

During operating the engine, observe coolant pipeline if any metal tube sealing-off, damage, cracked hose or loosen band. If any is encountered, retighten the loose parts or replace the damaged parts, eliminate any leaks. Otherwise the engine will not work properly.

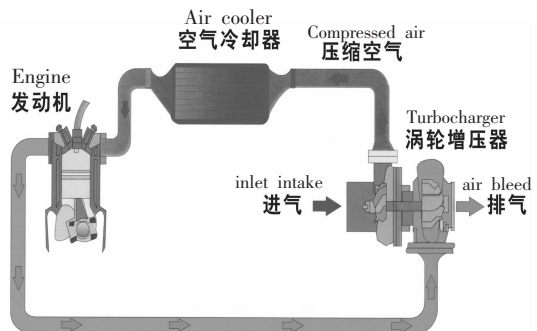
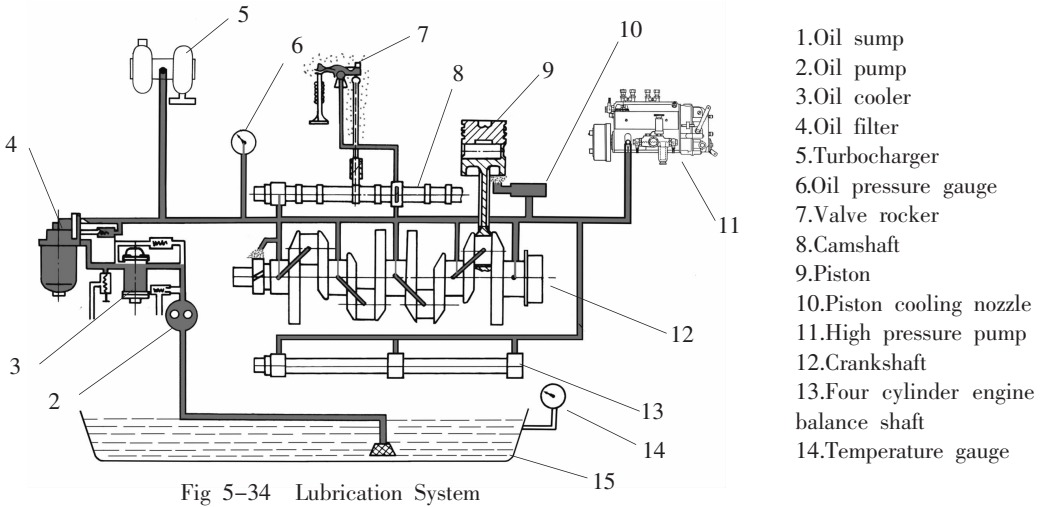

Fig 5-33 Turbocharged-intercooled Way

## 4 Lubrication System

4.1 Pressure-splash lubrication is used for YTO series engines. Lubrication system can make the moving parts get good lubrication so as to reduce friction power loss and parts excessive wear, and carry away heat and scraps caused by friction, and purify the lubrication continuously (see Fig 5-34).



- 1.Oil sump
- 2.Oil pump
- 3.Oil cooler
- 4.Oil filter
- 5.Turbocharger
- 6.Oil pressure gauge
- 7.Valve rocker
- 8.Camshaft
- 9.Piston
- 10.Piston cooling nozzle
- 11.High pressure pump
- 12.Crankshaft
- 13.Four cylinder engine balance shaft
- 14.Temperature gauge

4.2 Insert O-ring before installing oil pump, coat some oil on pump, tighten bolts, move gear freely without block (see Fig 5-35).

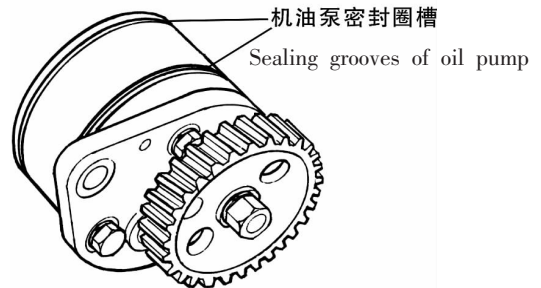

Fig 5-35 Sealing Grooves of Oil Pump



There are different flows in different series engine models. Purchase the correct oil pump according to the model on the nameplate or consult with your local dealer.

4.4 According to purpose and installation position, choose single stage oil filter with paper element or spin-on oil filter. When installing filter element, pay attention to gasket. Coat some oil on sealing ring, tighten bolts well (see Fig 5-36).

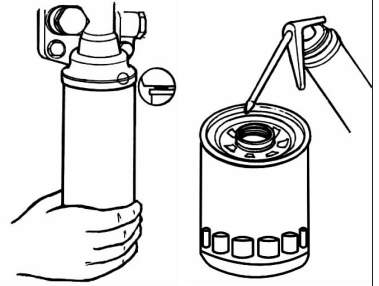

Fig 5-36 Below Type Oil Pump Installation

4.5 When oil pressure is up or blow regulated values, may adjust pressure through regulatory valve in a small range. Turn in clockwise to increase pressure, turn in anti-clockwise to reduce pressure (see Fig 5-37).

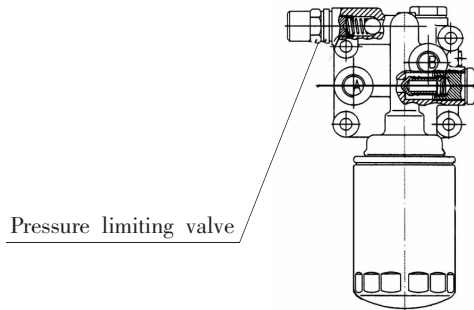

Fig 5-37 Oil Pressure Adjustment



During normal operation, if finding oil pressure lower than regulated limits, not only adjust regulatory valve to increase oil pressure, but also need to find causes and remove faults.

## 5 Fuel Supply and Injection System



5.1 Injection pump is precision components, repairing and adjustment can only be done by special persons on test bend. The connection between the compensator in some turbocharged engines and intake pipes should be installed firmly.

The Lubrications of some fuel injection pumps use the oil used in general diesel engine. Oil pipes connected main oil gallery should be installed firmly.



5.2 Never disassemble lead sealing on the injection pump by the customers.

5.3 YTO series engines use many kinds of injection pumps, such as PL, BW, ZBB BQ, PM and so on, but basically dismantling and installation methods are same. This manual introduces general methods and adjustment of fuel supply advance angle.



Before dismantling injection pump, open inspection window, use cleaning cloth to scrape oils on the gears, use a mark pen to make marks on injection pump gear with meshed with idle gear. Do not turn the engine so as to lead to troubled marks (see Fig 5-40). After calibrating fuel injection pump, reinstall pump as referred marks, and tighten bolts, then readjust fuel supply advance angle.

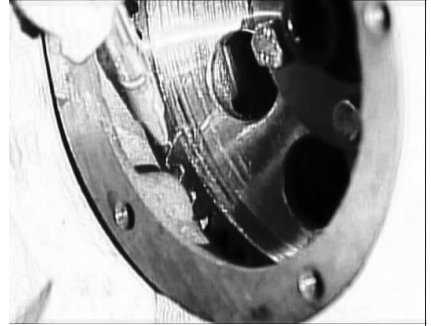

Fig 5-40 Marks in Gear

5.4 Adjusting method: loose 1st high pressure pipe, clear fuel on delivery valve port, put control rod in maximum fuel supply position, press hand primer to let air in pipe out. Turn engine slowly, when fuel appears on delivery port, stop to turn, observe finger on flywheel ring to angle marks on flywheel housing through inspection window, which is advanced angle (see Fig 5-41).

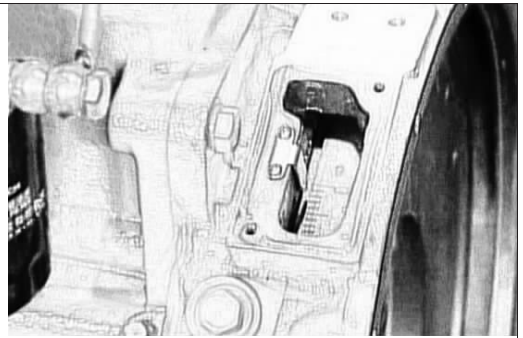
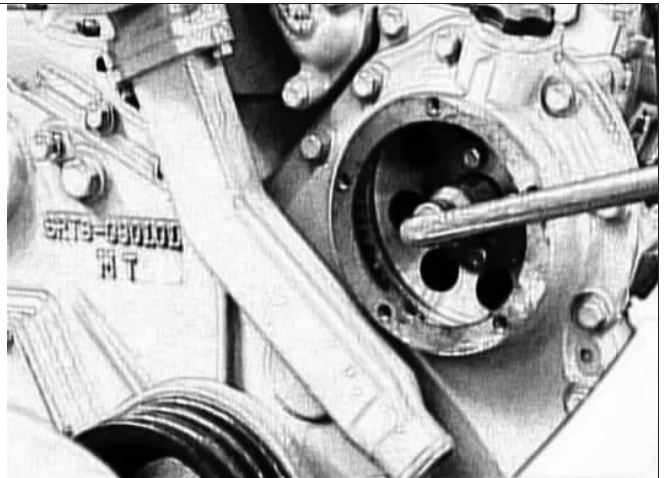

Fig 5-41 Mark on Flywheel Housing and Finger

5.5 If advanced angle is over required ranges, first align finger to required advanced angle mark, loose four pump gear cover plate bolts, turn injection pump with sleeve spanner, increase advanced angle clockwise, decrease angle counter-clockwise. Slowly turn engine to check fuel appear, then stop turning, tighten cover bolts, here advanced angle is correct angle as required.



5.6 Fuel supply advance angles have a significant effect on the engine performance. Adjust them according to relative contents in section 2 of chapter 7.

5.7 YTO series diesel engines use J series and P series injectors (see Fig 5-42). The opening pressure of J series injectors is 19.6~20.8MPa. The opening pressure of P series injectors is 25~26.2MPa. Adjust or replace the matching parts on the test-bed by professionals.

If injectors and its matching parts need to replace, keep original injector model consistently.

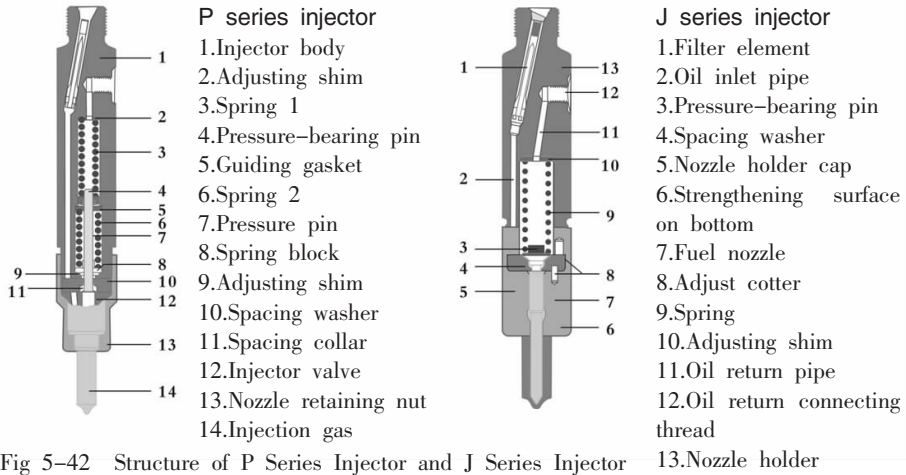

Fig 5-42 Structure of P Series Injector and J Series Injector

5.8 When installing injector, keep the injector hole clean. Install copper seal gasket at front end of injector, and then install the injector into cylinder head carefully. Tighten pressure plate screw firmly (see Fig 5-43).

Make sure the thickness of copper seal gasket is the same if the copper seal gasket needs to replace.

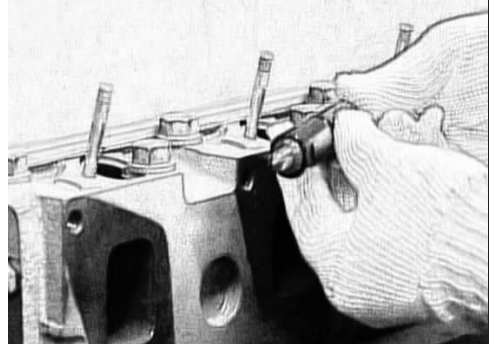

Fig 5-43 Injector Installation

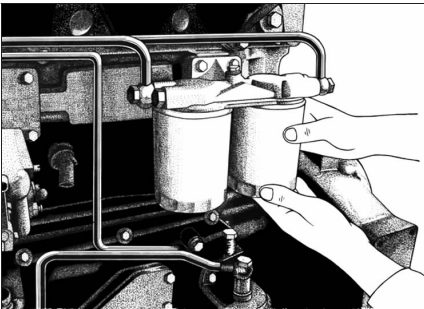

Fig 5-44 Replace Oil Filter Element

5.9 Replace the oil filter element regularly as specified procedures. First of all, close oil supply switch. Clean the oil and dirty outside diesel fuel filter housing. Remove the filter. Check the seal with filling oil after new filter is installed. Do not use the old element to avoid the faults due to injector nozzle pair damaged (see Fig 5-44).

## 6 Cooling System

6.1 Connect water pump with cylinder block by bolts, after installing, move V-belt pulley freely without block (see Fig 5-45).

During the operating, observe if there is water leakage in drain hole below the water pump body. If water leakage is serious, replace water block. The drain hole should not be blocked in order to prevent the bearing worn-out due to the water block going into bearing.

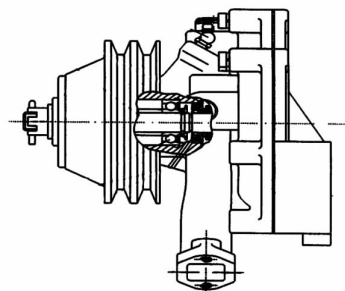

Fig 5-45 Connection between Water Pump and Cylinder Block



Because the machining of the impeller and shell of water pump belongs to the matching process, so water pump assembly must be replaced due to wear.

### 6.2 Fan and Belt

Make sure that cooling fan is installed reliably. Check for cracks on the fan. Replace damaged fan. Inspect the v-belt. When finding out the cracks and scratch, replace them.

Check the degree of the tightness of the V-belts every working 50~60 hours. Too tightening or loose can affect cooling effects and shorten V-belt using life. Press the V-belt between water pump and generator by hand. The deflection should be 10~15mm. Adjust the degree of the tightness of the V-belt by changing the position of the generator pulley (see Fig 5-46).

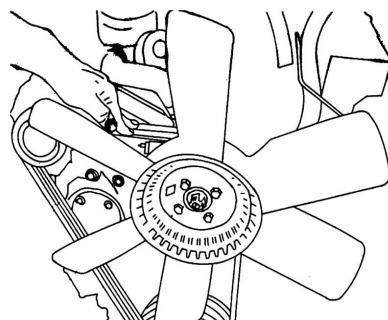

Fig 5-46 Fan and Belt Installation



Replace all the belts when changing. Do not use old and new one or different brands together so as to avoid different elongation and influence the efficiency of the cooling water pump.

### 6.3 Thermostat

The Opening temperature of main valve in thermostat is  $65\pm 2^{\circ}\text{C}$ . The temperature for thermostat full opening is  $76\pm 2^{\circ}\text{C}$ . The valve lift is 8~10mm (see Fig 5-47).

After the engine is started, the coolant flows out from water outlet when the coolant temperature does not reach specified temperature; or after the engine works

for some time, and the coolant temperature is above 65°C, the coolant does not flows out from water outlet, these mean that the thermostat is defective, replace it.

Harvests need not to install the thermostat due to hot temperature in summer, nor does generator sets due to working in closed environment.

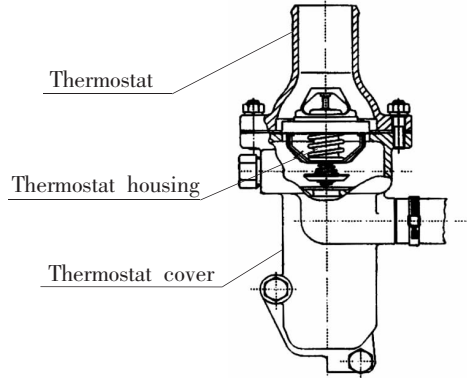

Fig 5-47 Structure of Thermostat



For the diesel engines with thermostat, do not dismount the thermostat during operation, otherwise, it will influence the engine operation and shorten its service life.

## 6.4 Radiator

6.4.1 Check leaks or damage of the radiator and remove any trash or dirty accumulating on the radiator daily. Clean or repair it as necessary (see Fig 5-48).

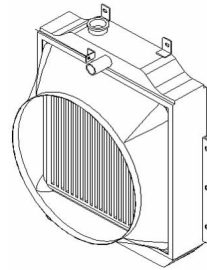

Fig 5-48



For the tractors working in the farmland, remove any trash or dirty accumulating on the radiator at any time.

6.4.2 During operating, the loss of the coolant should be checked and added at any time. Additive coolant should be clean soft water. After adding, let the engine start and run for some time. Check the level of coolant again. Add some coolant when needed (see Fig 5-49).

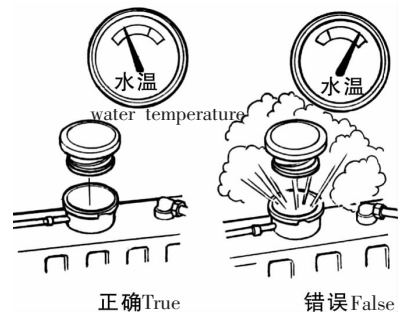

Fig 5-49 Check the Level of Coolant



Check the coolant level after the engine has been stopped. When the temperature is too hot, do not open the radiator filler cap to prevent people from scald.

6.4.3 Although soft water is used, however after some period of time, a little scale can be deposited in the cooling system, which can have negative effect on coolant circulation and heat exchange. Remove the scales regularly (see Fig 5-50).

The contents in detail are listed in section 5 of chapter 3.

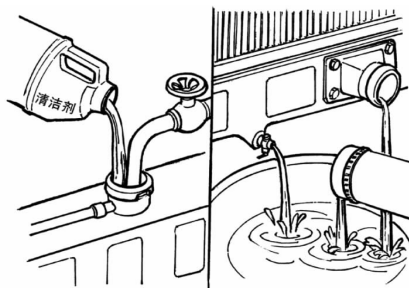

Fig 5-50 Remove Scales



When the ambient temperature is below 5°C and the coolant is without anti-freeze additives, open the water drain cock on the cylinder, radiator and oil cooler to drain the cooling system after the engine has been stopped.

## 7 Electrical System

12 V and 24 V electrical system is available according to engine applications. The engine is equipped with AC alternator and starter at shipping. The generator governor, pre-heater and instrument sensors are optional.

### 7.1 Alternator

The purpose of the alternator is to charge the battery and to supply electrical power to other loads. JFZ series unit alternator (with regulator), JF series alternator, JFW series alternator are available. The basic structure and principle of the three alternators are the same.

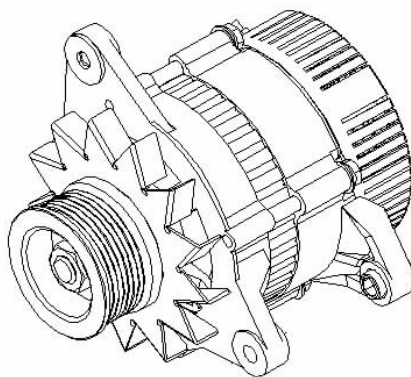

Fig 5-51 Alternator

As a part of electrical system, the wiring between the alternator and other electrical elements refer to the electrical diagram. Fig5-52 and Fig5-53 are principle and wiring diagrams.

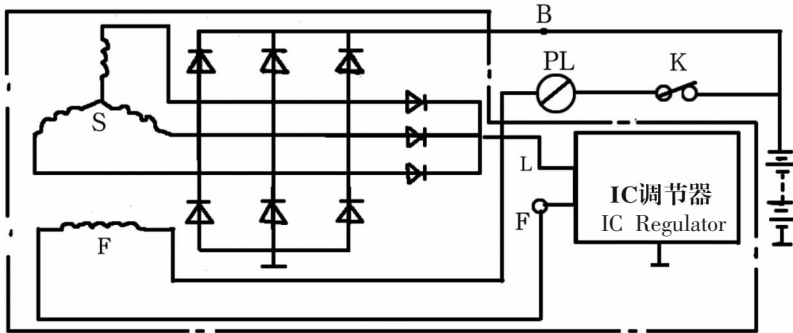
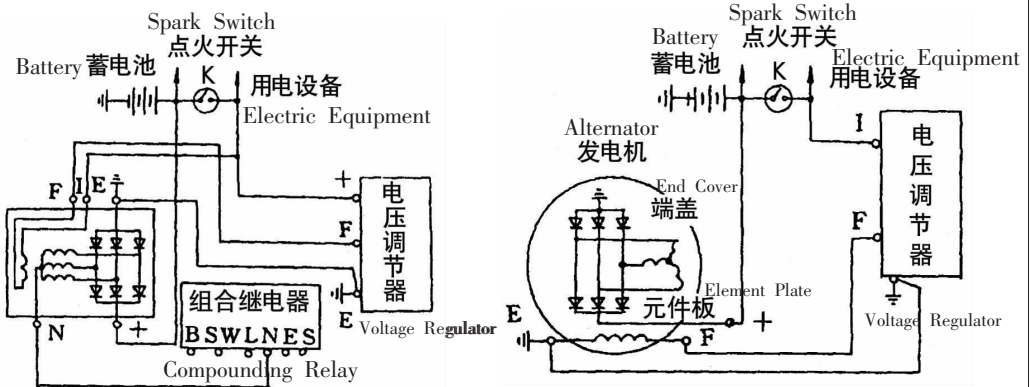

Fig 5-52 wiring diagram of unit alternator



(a) Inner negative

(b) Outer negative

Fig 5-53 Principle and Working Sketch of AC Alternator

## 7.2 Alternator operation and maintenance

7.2.1 Do not use short circuit to check the alternator charging.

7.2.2 Use the negative earth. When using in parallel with batteries, pay attention to the earth connection.

7.2.3 Remove the dirt on the alternator especially on the terminals regularly so as to keep the terminals in proper connection.

7.2.4 Check the tension and wear of V-belt, and adjust it in time.

7.2.5 Maintain the alternator every 900~1000 working hours or every 30000~40000 km of the vehicle. Clean the bearings with gasoline, kerosene is forbidden. Add No.3

complex calcium base grease or No.4 high temperature grease to the bearings. The quantity is about 1/3-1/2 of the bearing chamber.

7.2.6 When the engine is stopped, turn the start switch to "OFF" position to prevent electric current coming from the battery into the magnetic field winding (see K switch in Fig5-53).

### 7.3 Starter

The function of the starter is to start the engine. 12 V and 24 V starters are available. The starter consists of DC motor, magnetic switch and free-wheeling clutch. The starter is connected with main electrical system by the magnetic switch.

The starter is shown in Fig 5-54.

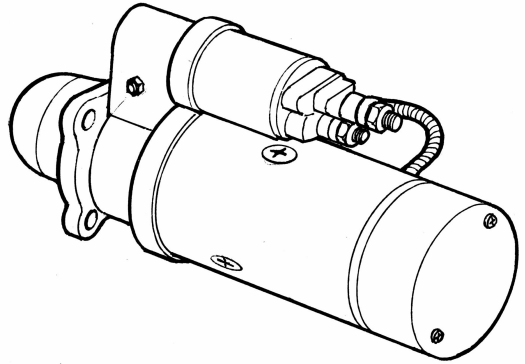

Fig 5-54 Starter

### 7.4 Usage Notice for Starter

7.4.1 The battery should be installed as soon as possible nearby the starter so as to reduce line drop.

7.4.2 The time of startup must be restricted in 10 seconds. If the engine does not start, wait for 2 minutes. Start it again. It is prohibited to start the engine for a long time or start the engine continuously.

7.4.3 If the magnetic switch will not return automatically after the engine is started, which means the key is released from the starting position but the starter continues running, turn off the main electrical power switch to look for the causes.



Do not allow to operate the starter by using short circuit.

## 8 Sensor Interface

8.1 Oil pressure sensor: oil pressure sensor is connected with the detecting instruments, and installed in the main oil gallery on left side of cylinder body.

8.2 Oil pressure alarm: optional device. Oil pressure alarm is connected with the oil pressure alarming system, and installed in the main oil gallery on left side of cylinder body (see Fig 5-55).

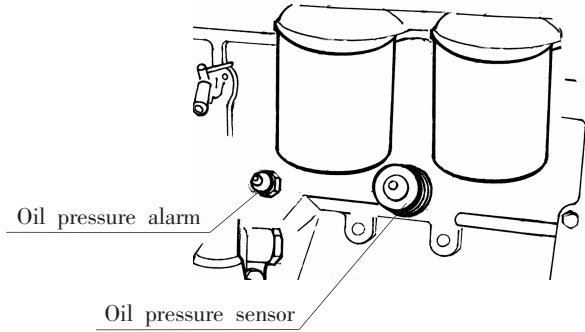

Fig 5-55 Oil Pressure Alarm System

8.3 Water temperature sensor: water temperature sensor is connected with the detecting instruments, and installed on the thermostat housing (see Fig 5-56).

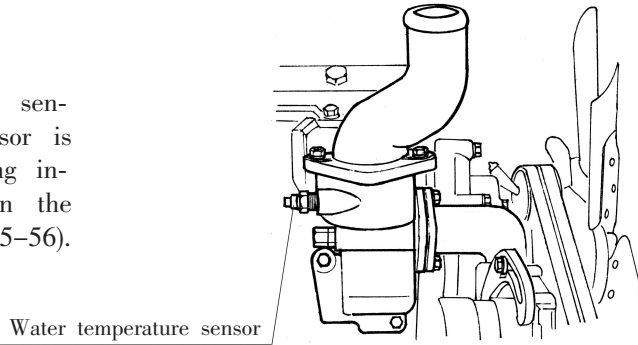

Fig 5-56 Water Temperature Sensor

8.4 Oil temperature sensor: optional equipment. Oil temperature sensor is connected with the detecting instruments, and installed on the oil sump (see Fig 5-57).

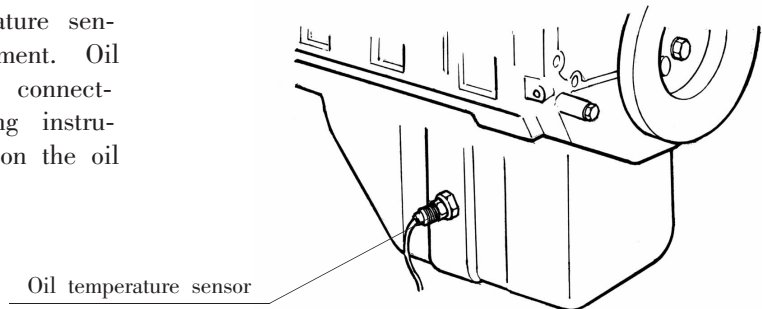

Fig 5-57 Oil Temperature Sensor



## Chapter 6 Troubleshooting



When the engine has some faults, you should remove them. If the engine works with faults, it will not only result in low power, low efficiency, but also in excessive parts abrasion, and even machine damage.

The items marked with "★" in troubleshooting table are the fault which may happen to the electronic injection diesel engine, but for the engine without electronic injection, it doesn't matter.

The common malfunctions are: hard to start, running rough, low power, abnormal running sound, abnormal smoke low oil pressure, over-heated coolant, automatic shut down, running-away and so on.

When the engine has some faults, you should remove them. If the engine works with faults, it will not only result in low power, low efficiency, but also in excessive parts abrasion, and even machine damage.

For removing the faults as soon as possible, the following procedures are suggested:

(1) Before removing the faults, you had better understand the features and details of faults such as the load, ambient temperature and altitude and other conditions.

(2) Analyze the faults carefully.

(3) Consider the relationship between the faults and the relevant engine system and parts.

(4) Review the latest service or repair and make a careful check.

(5) Remove the faults from the most easy ones.

(6) Find out the causes and remove them.

(7) Start the engine, make sure the faults have been eliminated.

Some of the typical faults and their elimination methods are as follows:

### 1 Engine hard to start

| Cause   | Solution                                 |
|---|--|
| <b>1.Engine hard to start</b>                               |  |
| (1)Low battery  | →Recharge the battery                    |
| (2)Bad electrical contact                                   | →Remove ill contact                      |
| (3)Starter gear does not engage with the flywheel ring gear | →Find out the causes and correct them.   |
| <b>2.Malfunction of fuel supply system</b>                  |  |
| (1)Fuse burnt ★   | →Change fuse                             |
| (2)Fuel tank without fuel                                   | →Add the fuel                            |
| (3)Jams in outlet pipes                                     | →Clean and make it smoothly              |
| (4)Air in the fuel system                                   | →Bleed the system                        |
| (5)Jams in the fuel pipes or fuel filter                    | →Clean the fuel pipes, and change filter |
| (6)Poor quality fuel injection or low injection pressure    | →Clean and repair the injector           |
| (7)Loose connector in electrical equipment ★                | →Fasten connectors                       |
| (8)Abnormal power supply of ECU controller ★                | →Check supply circuit of ECU controller  |

| Cause  | Solution   |
|--|--|
| (9)Low engine temperature  | →Use winter lubrication and fuel, switch on the electric heater          |
| (10)Incorrect installing gap of cam speed sensor or sensor damaged ★                                       | →Adjust installing gap of cam speed sensor or replace the sensor         |
| (11)Power supply of cam and crankshaft speed sensors or temperature pressure sensor is shorted to ground ★ | →Replace cam and crankshaft speed sensors or temperature pressure sensor |
| (12)Fault diagnosis switch is turned on before starting ★  | →Turn off fault diagnosis switch, and resupply power to make it return   |
| (13) ECU controller damaged ★  | →Replace ECU controller  |
| (14)Back pressure valve damaged ★  | →Replace Back pressure valve   |
| <b>3.Low compression pressure in cylinder</b>  |  |
| (1)Piston ring worn out  | →Replace piston ring   |
| (2)Valve leakage   | →Check and rub valve   |
| <b>4.Low ambient temperature</b>   | →Use pre-heater  |
| <b>5.Jam in air cleaner</b>  | →Check, clean or change air filter                                       |

## 2 Running rough

| cause  | solution   |
|--|--|
| 1.Air or water in fuel system                    | →Bleed the system and check water content in the diesel fuel |
| 2.Malfunction fuel transfer pump                 | →Repair or replace fuel transfer pump                        |
| 3.Valve spring break or improper valve clearance | →Replace valve spring and readjust the valve clearance       |
| 4.Gas leakage                                    | →Replace cylinder head gasket                                |

## 3 Lack of engine power

| Cause   | Solution   |
|---|--|
| <b>1.Turbocharged system</b>  |  |
| (1)Leaks in inlet pipe of turbocharger  | →Find out leaks in pipes and tubes of turbocharger and intercooler, and correct them |
| (2)Leaks in exhaust pipe of turbocharger  | →Replace gasket. Find out leaks and correct them                                     |
| (3)Turbocharger works abnormally  | →check   |
| <b>2.Fuel supply system</b>   |  |
| (1)Fuel pipes and fuel filter throttled   | →Clean fuel pipes and filter or replace filter element                               |
| (2)Water in fuel  | →Drain out the water and change fuel   |
| (3)Injector damaged   | →repair or replace   |
| (4)Bad contacts between connector and pressure temperature sensors or sensor damaged★ | →Check pressure sensor connector or replace super-charged pressure sensor            |
| (5)Injection pump performance reduction or does not work                              | →Adjust flow coefficient or replace injection pump                                   |
| (6)Scrap iron is absorbed by crankshaft speed sensor★                                 | →Remove scrap iron on crankshaft speed sensor  |

| Cause  | Solution   |
|--|--|
| (7) Poor contacts in throttle sensor or sensor damaged★        | → Plug in and pull out connector again or replace throttle |
| (8) Low engine temperature results in throttle without output★ | → Wait for engine warm-up                                  |
| 3. Air cleaner blocked   | → Clean or replace air filter                              |
| 4. Muffler blocked   | → Clean muffler  |
| 5. Low pressure in cylinder                                    |  |
| (1) Valve spring break   | → replace valve spring                                     |
| (2) Incorrect valve clearance                                  | → Adjust valve clearance                                   |
| (3) Valve leakage  | → Rub valve  |
| (4) Piston ring soot or worn-out                               | → Clean soot or replace piston ring                        |

#### 4 Abnormal noise

| Cause   | Solution  |
|---|---|
| 1. Excessive clearance between piston and cylinder results in knock sound in the cylinder after engine starts and it will go less with engine warm-up | → Replace piston or cylinder liner  |
| 2. Excessive clearance between piston pin and small end bushing of connecting rod results in clear knock on the top of cylinder at low speed          | → Replace small end bushing of connecting rod                                       |
| 3. Excessive valve clearance results in rhythmical knock at valve cover.  | → Adjust valve clearance  |
| 4. Excessive valve clearance of connecting rod bearing shell or main bearing, there are clash noise at low speed                                      | → Replace main bearing or connecting rod bearing shell                              |
| 5. Turbocharger noise   | → Look for friction between impellers and the housing of turbocharger or compressor |
| 6. Driver gear noise  | → Replace gears   |

#### 5 Black smoke

| Cause  | Solution  |
|--|---|
| 1. Engine over-load  | → Reduce engine load                                |
| 2. Bad fuel spraying   | → Check or replace injector                         |
| 3. Leakage at the connection of turbocharger and the intake pipe or exhaust pipe | → Look for the leaks and correct them               |
| 4. Turbocharger failure  | → Replace turbocharger                              |
| 5. Transient state switch without opening★                                       | → Turn on transient state switch                    |
| 6. Scrap iron is absorbed on crankshaft speed sensor★                            | → Remove scrap iron on crankshaft speed sensor      |
| 7. ECU control procedure is not compatible★                                      | → Replace ECU control procedure or ECU control unit |
| 8. Defective intercooler   | → Clean intercooler or repair fan                   |
| 9. Air cleaner blocked   | → Check, clean or replace filter element            |

## 6 White smoke

| Cause  | Solution   |
|--|--|
| 1.Low ambient temperature                            | →Warm up engine with low load  |
| 2.Low coolant temperature or water in cylinder       | →Warm up coolant, find out the sources of water in cylinder and correct them |
| 3.Poor fuel spraying or leaks                        | →Repair or replace injector  |
| 4.Scrap iron is absorbed on crankshaft speed sensor★ | →Remove scrap iron on crankshaft speed sensor                                |
| 5.Water in fuel                                      | →Wash fuel tank and filter, change fuel                                      |
| 6.Cylinder score                                     | →Repair or replace piston and cylinder liner                                 |

## 7 Blue smoke

| Cause                               | Solution                    |
|-------------------------------------|-----------------------------|
| 1.Poor fuel spraying                | →Repair or replace injector |
| 2.Piston ring installed upside down | →Reinstall piston ring      |
| 3.Piston ring worn-out              | →Replace piston ring        |

## 8 Lack of Oil Pressure



Never operate the engine when engine oil pressure is too low. Whenever when engine oil pressure is too low, stop the engine immediately. Find out the causes and correct them

| Cause   | Solution  |
|---|---|
| 1.Oil pressure gauge or sensor damaged  | →Replace gauge or sensor, check connect lines           |
| 2.Low level in oil sump   | →Add oil to specified level                             |
| 3.Oil screen, oil filter plugged or filter bypass valve stuck                             | →Clean Oil screen, adjust or replace bypass valve       |
| 4.Main relief valve failure   | →Adjust or replace relief valve                         |
| 5.Leaks in oil inlet or outlet pipe of turbocharger                                       | →Look for the leaks, tighten or replace oil pipe        |
| 6.Excessive clearance at connecting –rod bearing, crankshaft bearing and camshaft bearing | →Replace the bearing                                    |
| 7.Damaged or wear-out oil pump  | →Find out the causes and correct them                   |
| 8.Improper engine oil   | →Change with correct engine oil and find out the causes |

## 9 Coolant is too hot



When the coolant in engine radiator is boiling, do not stop the engine immediately or add cold water in it. To avoid cylinder liner damage, the speed should be reduced, and keep the engine run at low speed until the coolant temperature becomes lower. Then stop the engine to find out the causes.

| Cause   | Solution   |
|---|--|
| 1.Damaged coolant temperature gauge or sensor                         | →Check and replace coolant temperature gauge or sensor |
| 2.Excess fuel injection quantity                                      | →Check or replace fuel injection pump (or readjust)    |
| 3.Overload  | →Reduce load   |
| 4.Low coolant level, V-belt loose                                     | →Add coolant, adjust V-belt tension                    |
| 5.Damaged thermostat  | →Replace thermostat                                    |
| 6.Serious scale deposit in the water jacket of cylinder head or block | →Scour out the jacket and Clean cooling system         |
| 7.Damaged cylinder liner O-ring, leaks in cooling system              | →Replace sealing ring or correct leaks                 |
| 8.Intercooler or radiator is too dirty                                | →Clean intercooler or radiator                         |
| 9.Damaged water pump  | →Check or replace water pump                           |

## 10 Engine stalls abruptly

| Cause   | Solution  |
|---|---|
| 1.Engine stalls abruptly and crankshaft can be cranked    |   |
| (1)Engine overloaded                                      | →Reduce loads and restart engine                      |
| (2)Fuel tank without fuel                                 | →Add fuel to fuel tank                                |
| (3)Air in fuel supply system                              | →Bleed the system                                     |
| (4)clogged fuel supply system                             | →Clean fuel supply system                             |
| (5)Air cleaner clogged                                    | →Clean or replace filter element                      |
| (6)Short circuit caused by damaged sensor ★               | →Replace sensor                                       |
| (7)Loose plug of cam speed sensor ★                       | →Check cam speed sensor plug or replace sensor        |
| (8)Damaged controller ECU ★                               | →Replace controller ECU                               |
| (9)Coolant temperature is too hot                         | →Check coolant system                                 |
| (10)Damaged wiring harness ★                              | →Replace wiring harness                               |
| (11)Impurity is absorbed on cam sensor ★                  | →Clean impurity on sensor                             |
| (12)Ground connection is bad ★                            | →Connect earth line well                              |
| 2.Engine stalls abruptly and crankshaft cannot be cranked |   |
| (1)Crankshaft and bearing stuck                           | →Check crankshaft and bearing, repair or replace them |
| (2)Piston and cylinder liner stuck                        | →Replace piston and cylinder liner                    |

## 11 Runaway



When runaway happens, try to stop the engine immediately. The general way is as follows: stop the engine and cut off fuel and air supply so as to avoid personal injury or machine damage. When runaway happens on tractors, vehicles and construction machinery except the measures mentioned above, depress the brake pedal to stall the engine. However never depress clutch pedal.

| Cause  | Solution  |
|--|---|
| 1.Controller ECU works abnormally★                     | →Replace or repair controller ECU   |
| 2.Injection pump works abnormally                      | →Replace or repair Injection pump   |
| 3.Throttle line failure(including whole vehicle)★      | →Check throttle line  |
| 4.Pre-heater failed, much fuel in intake pipe          | →Replace pre-heater, clean up fuel in intake pipe   |
| 5.Incorrect oil or too much oil in oil bath air filter | →Change with correct oil, set oil level to specified level, and wash intake pipe and intake passage |
| 6.Excessive oil in oil sump                            | →Drain out excessive oil, and clean air intake pipe   |

## 12 Lack of power, higher fuel consumption due to excessive wear



The sealing in the air inlet pipeline should be frequently checked. If any leak happens, find out the causes and remove them immediately to avoid lack of power or excessive wear.

Turbocharged engines should use ADI CF grade oil. Common oil is prohibited. When changing oil, do not mix with used oil or other brands oil.

| Cause  | Solution  |
|--|---|
| 1.Parts excessive worn out due to incorrect oil  | →Clean oil sump and oil filter, replace element, add specified oil, replace worn components |
| 2.Cylinder liner, piston ring and bearing damaged due to not changing oil for a long time or use incorrect oil | →Same as above  |
| 3.Injector pair wear or plugged  | →Replace or clean injector pair   |
| 4.Parts seriously worn out due to damaged air filter   | →Replace element or air cleaner, replace parts as necessary                                 |
| 5.Piston, cylinder liner, piston ring seriously worn out due to leaks or other trouble in air intake system    | →Find out causes and correct them, replace parts as necessary                               |

## 13 Low air pressure or oil leaks of air compressor

| Cause  | Solution  |
|--|---|
| 1. Low air pressure  |   |
| (1)Soot on intake or exhaust valve or diaphragm broken or too weak | →Replace diaphragm, rub valve seat and remove soot                                |
| (2)Loose cylinder head bolts or leaks at valve seat gasket         | →Retighten bolts and replace gasket   |
| (3)Safety valve can not close completely                           | →Clean safety valve, remove dirt at air intake or exhaust port and replace spring |
| (4)Air filter plugged  | →Clean air filter   |
| (5)Leaks or plugged at the pipe connection                         | →Tighten nuts, remove soot or dirt  |
| 2. Too much lubrication oil consumed                               |   |
| (1)Cylinder liner or piston ring worn out                          | →Replace cylinder liner or piston ring  |

| Cause  | Solution                               |
|--|--|
| (2)Oil return orifice plugged, or high oil level | →Clean oil sump and oil return orifice |
| <b>3. Leaks on joint surface</b>                 |  |
| (1)Loose fasteners                               | →Tighten bolts                         |
| (2)Damaged gaskets                               | →Replace gasket                        |

## 14 Alternator faults

| Cause  | Solution   |
|--|--|
| <b>1.Alternator does not work</b>  |  |
| (1)Electrical wire broken, short circuit, improper connection or wire connected incorrectly  | →Connect wire tightly and correctly                            |
| (2)Loose Claw pole, rotor winding broken, damaged rectifier bridge, bad brush connect  | →Repair and replace components as necessary                    |
| (3)Low regulator voltage, wire connected incorrectly, contact point burnt or oxidated , relay winding burnt  | →Repair and replace components as necessary                    |
| <b>2.Undercharge</b>   |  |
| (1)Damaged rectifier bridge, bad brush connect, weaken spring, grease on slip ring, loose V-belt   | →Repair and replace alternator                                 |
| (2)Low regulator voltage, connect point burnt  | →Repair and replace regulator                                  |
| (3)Insufficient battery electrolyte, obsolete battery  | →Add specified electrolyte or replace battery                  |
| <b>3.Unsteady charging</b>   |  |
| (1)Loose V-belt, bad brush connect, weaken spring, loose terminal or improper contact  | →Tighten V-belt, adjust brush and spring, screw down terminals |
| (2)Dirty regulator contactor   | →Clean regulator contact point                                 |
| <b>4.Abnormal noise</b>  |  |
| (1)Alternator improperly installed   | →Re-install alternator as necessary                            |
| (2)Damaged bearing, friction between stator and rotor or stator winding short circuit  | →Repair or replace alternator                                  |
| <b>5.Charging current is too high</b>  |  |
| (1)High regulator voltage or regulator failed  | →Repair regulator  |
| (2)Brush runs into rectifier or short circuit with armature. Current output goes directly to excitation coil which results in uncontrollable voltage | →Repair alternator   |
| <b>6.Alternator damaged</b>  |  |
| (1)Rectifier element short circuit or friction between stator and rotator  | →Repair alternator, replace it as necessary                    |
| (2)Damaged regulator   | →Repair regulator, and replace it as necessary                 |

## Chapter 7 Main Data of Maintenance

### 1 Main torque specifications

The torque specifications of YTO LR-R, A, B, M, N series engine are listed in the table 7-1.

Table 7-1 Torque Specifications

| Name                                       | Torque/ N.m                    | Name  | Torque/ N.m  |
|--|--------------------------------|---|--|
| Cylinder head set bolts<br>(common gasket) | natural-aspirated<br>196-206   | Main bearing bolts<br>Connecting-rod bolts<br>Flywheel securing bolts | 201 <sup>+4.9</sup> <sub>0</sub><br>132 <sup>+4.9</sup> <sub>0</sub><br>206 <sup>+4.9</sup> <sub>0</sub> |
|  | turbocharged engine<br>220-230 |   |  |

### 2 Main adjustment specifications

#### 2.1 Valve clearance

The Valve clearances of YTO YT-A, B, J, M series diesel engine are listed in the table 7-2.

Table 7-2 Valve clearances of YTO YT-A, B, J, M Series Diesel Engines

| Valve            | Clearance/ mm | Valve         | 間隙/ mm    |
|------------------|---------------|---------------|-----------|
| Air intake valve | 0.30~0.40     | Exhaust valve | 0.40~0.50 |

2.2 Needle-valve opening pressure: P series: 25~26.2 MPa; J series: 19.6~20.8MPa

2.3 Piston-to-head clearance: 1.1±0.1 mm

2.4 Fuel supply advance angle (static state): For tractors and construction machinery: 12°±1°



For some engines with electric control or higher rank configuration, fuel supply advance angles are subject to change, please consult with the host manufacturer in detail.



## Chapter 8 Main Technical Specifications

### 1、Instruction to specifications table

With the continuous advancement of technology, in order to fully meet customer's requirements on engine usage, the original establishment rules of YTO YT-A, B, J, M series engines model spectrum do not meet the actual application. The specification tables in this manual are organized according to new model spectrum, and some explanation for specific parameter is gave. The illustrative items marks with \*, and which corresponds to the parameters in specification table.

\* 1、Model: for some engines, new and origin model are listed at the same time, for new developed engines, new models are only listed. There are the same meanings among corresponding models in table. The suffix part of the model represents the practical application area, but it is not listed in specification table. In general condition, the letter in the suffix part shows application field of the engine, for example, the letter Q represents the engine is used for vehicles, the letter T represents the engine is used for tractors, the letter G represents the engine is used for construction machinery, the letter D represents the engine is used for generator sets, the letter C represents the engine is used for marines.

\* 2、Power range; minimum power in power ranges means the power when the engine adopts natural-aspirated technology and runs at the speed of 1500r/min, maximum power means the power when the engine adopts turbocharged or turbocharged intercooled air intake technology and runs at the speed of 2400r/min. Of course, for different application conditions, some models may be not adequate for low speed running and turbocharged-intercooled air intake technology.

\* 3、Speed range: the choice of the speed is decided by application areas. In general condition, the speed of the engine used for power generation and marines is less than 2000 r/min, the speed of the engine used for other application areas is 2000 r/min to 2400 r/min. Of course, this also depends on the choice of manufacturer in actual application conditions.

\* 4、Torque reserve ratio: it is not suitable for some engines, such as generator sets and marines.

\* 5、Lowest fuel consumption: lowest fuel consumption is obtained when the engine adopts higher configuration, which is different from that of the engine with lower configuration. Meanwhile lowest fuel consumption is also affected by actual environment.

\* 6、Emission standard: emission data is obtained when the engine adopts higher rank configuration, the engine with lower rank configuration will not meet this index.

\* 7、Infrastructure weight: the natural-aspirated diesel engine is used as a reference. For the engines working in different application areas or with higher configuration, the structure weigh should be accordingly increased. For an example, when your engine installs any exterior component, such as turbocharger, air intercooler, sea-water exchanger, radiator etc., this will make the weight of the engine become bigger.

### 2、Other instruction

2、1 For natural-aspirated engines, the altitude in normal operation is not above 2000m (at the altitude of 2000m, the engine will have a power reduction). When the engine works at more than 2000m above sea level, please choose plateau type turbocharged diesel engines.

2、2 Due to continuous improvements, specifications are subject to change without notice.

## YTO LR-R, A, B, M, N Series Engines Random Spare Parts Packing List

| No. | Part Name   | Quantity. |
|-----|---|-----------|
| 1   | Flood pipe union screw gasket                               | 4         |
| 2   | Injector gasket   | 2         |
| 3   | Aluminum gasket   | 4         |
| 4   | Oil filter  | 1         |
| 5   | Drive belt  | 2         |
| 6   | Oil-filter wrench   | 1         |
| 7   | 《YTO LR Diesel Engine Operation & Maintenance Manual》       | 1         |
| 8   | YTO LR Series Diesel Engine Operation & Maintenance-DVD     | 1         |
| 9   | YTO LR Series Diesel Engine Random Spare Parts Packing List | 1         |
| 10  | 《YTO LR Series Diesel Engines Warranty Card 》               | 1         |

Notice: the model in this list is basic engine model. Random spare parts are different due to different engine models.

## YTO LR-R, A, B, M, N Series Diesel Engines Wearing Parts List

| No. | Type                              | Part  | Notes |
|-----|-----------------------------------|---|-------|
| 1   | According to the actual situation | Gasket, cylinder head                         |       |
| 2   | According to the actual situation | Sealing gasket, cylinder head hood            |       |
| 3   | According to the actual situation | Gasket, push rod chamber cover assembly       |       |
| 4   | According to the actual situation | Nonmetal sealing gasket ,all of the machinery |       |
| 5   | According to the actual situation | 1st compression ring                          |       |
| 6   | According to the actual situation | 2nd compression ring                          |       |
| 7   | According to the actual situation | Inner sustain oil ring                        |       |
| 8   | According to the actual situation | Piston  |       |
| 9   | According to the actual situation | Cylinder liner                                |       |
| 10  | According to the actual situation | Thrust shell(top),main bearing                |       |
| 11  | According to the actual situation | Thrust shell(bottom),main bearing             |       |
| 12  | According to the actual situation | Bottom shell,main bearing                     |       |
| 13  | According to the actual situation | Top shell,main bearing                        |       |
| 14  | According to the actual situation | Shell,connecting rod                          |       |
| 15  | According to the actual situation | Nozzle  |       |
| 16  | According to the actual situation | Delivery valve pair                           |       |
| 17  | According to the actual situation | Foreside and rear oil sealing housing         |       |
| 18  | According to the actual situation | Sealing ring, cylinder liner                  |       |
| 19  | According to the actual situation | Temperature sensor                            |       |
| 20  | According to the actual situation | Rev sensor                                    |       |
| 21  | According to the actual situation | Press sensor                                  |       |
| 22  | According to the actual situation | Kinds of oil pipes                            |       |
| 23  | According to the actual situation | Driving pulley                                |       |
| 24  | According to the actual situation | Fuel filter                                   |       |
| 25  | According to the actual situation | Rotary oil filter                             |       |
| 26  | According to the actual situation | Air cleaner                                   |       |
| 27  | According to the actual situation | Alternator and bracket assembly               |       |
| 28  | According to the actual situation | Turbo-changer                                 |       |
| 29  | According to the actual situation | Starter installation assembly                 |       |
| 30  | According to the actual situation | Air compressor installation assembly          |       |
| 31  | According to the actual situation | Driving splind sleeve,hydraulic pump          |       |
| 32  | According to the actual situation | wiring  |       |
| 33  |                                   |   |       |
| 34  |                                   |   |       |

YTO YT-A, B, J, M series diesel engines production

license No. and license term:

Rotated power  $\leq 266.00\text{kW}$

Production license No: XK06-002-00114

License term: July 6, 2013



**YTO (LUOYANG) POWER MACHINERY CO.,LTD.**